



01618987201100522200210217

I, Richard Hobernicht, Director of Assessment and Taxation and Ex-Officio County Clerk for Washington County, Oregon, do hereby certify that the within instrument of writing was received and recorded in the book of records of said county.

Richard Hobernicht, Director of Assessment and Taxation, Ex-Officio County Clerk



After recording, please return to:
City of Sherwood
Engineering Department
22560 SW Pine Street
Sherwood, OR 97140

PERMANENT EASEMENT (Individual Grantor)

PORTLAND GENERAL ELECTRIC COMPANY, an Oregon Corporation, GRANTOR, does on behalf of GRANTOR, GRANTOR'S heirs, successors and assigns hereby grant and convey to the CITY OF SHERWOOD, a political subdivision of the State of Oregon, GRANTEE, the following permanent nonexclusive easement(s) in that certain real property situated in the City of Sherwood as described in Exhibit "A" (Legal Description) and Exhibit "B" (Location Map), attached hereto and by this reference incorporated herein.

The monetary consideration for this conveyance is \$0.00. However, the true consideration is the mutual promises contained herein and other good and valuable consideration, the receipt and sufficiency of which is hereby acknowledged.

This document is intended to establish permanent nonexclusive easements on the property described, not to convey fee title or any interest in the underlying property except as expressly stated herein. The easements granted shall not prevent GRANTOR from the use of said property provided, however, that such use shall not be permitted to unreasonably interfere with the rights herein granted. GRANTOR shall not be permitted to endanger the lateral support of any facilities constructed within the easements granted herein. GRANTEE accepts the property and the easement "AS IS" in the condition now existing with no improvement, alteration or other work to be performed by GRANTOR.

GRANTOR hereby covenants to and with GRANTEE that GRANTOR is the owner of said property, which is free from all encumbrances, except for easements, encumbrances, conditions and restrictions of record, and will warrant and defend the easement rights herein granted from all lawful claims whatsoever, except as stated herein.

GRANTEE (and other public or private entities or persons GRANTEE deems in its reasonable discretion as appropriate) shall have the right to use the property as necessary to install, construct, operate, maintain, repair, replace, remove or reconstruct utilities, including but not limited to water, wastewater, drainage, electric, fiber optic, telephone and cable, as GRANTEE may reasonably deem necessary over, across, through, in and under the property described in Exhibits "A" and "B", hereinafter called "Public Utility Easement"; provided, however, that all utility connections (pipes, conduits, wires) shall be underground and no above-ground facilities shall be erected within the easement area except for such surface-mounted pedestals, fences, cabinets, transformers or other facilities necessary for and accessory to the underground utilities. GRANTOR reserves all right to grant additional easements, licenses, or other rights to third parties within or across the subject property including the easement subject to the terms and conditions of this Easement.

GRANTOR reserves the right to use and maintain its equipment, facilities and property interests including the right and power of GRANTOR to construct, maintain, repair, reconfigure, renew, use, operate, change, modify or relocate any of GRANTOR's new or existing property or facilities, all or any of which may be freely done at any time or times by GRANTOR without liability to GRANTEE or to any other party for

compensation or damages. GRANTEE, and any assignee or successor in interest, shall upon not less than ninety (90) days prior written notice from GRANTOR, at the sole expense of GRANTEE, move all or any portion of GRANTEE's facilities to such new location on GRANTOR's property, as GRANTOR may designate, whenever, in the furtherance of its needs and requirements, GRANTOR, at its sole election, determines such action necessary or desirable.

GRANTEE shall conduct all activities performed by or on behalf of GRANTEE pursuant to the easement in compliance with all applicable federal, state and local laws and regulations, orders, permits or governmental approvals.

GRANTEE shall, to the extent allowed by the Oregon Constitution and the Oregon Tort Claims Act (ORS 30.260 to 30.300), indemnify, defend, and hold GRANTOR and its affiliates or their employees, agents or contractors, harmless for, from and against all claims, demands, actions, suits, liabilities, damages, costs, expenses (including reasonable attorney fees and costs) and other losses, suffered or incurred by GRANTOR or its affiliates or their employees, agents or contractors, arising from or relating to (i) the negligent acts or omissions, (ii) release of hazardous or toxic substances or materials, (iii) violations of applicable federal, state or local laws or regulations, orders, permits or governmental approvals, and (iv) breach of any term of this easement, by or of GRANTEE or its agents', employees' or contractors' on or about or acting pursuant to the easement.

// //

// //

// //

IN WITNESS WHEREOF, the above named Grantor, has caused this instrument to be signed.

DATED this 6th day of JULY, 2011.

PORTLAND GENERAL ELECTRIC COMPANY

By: Bill Nicholson JLN
GRANTOR (Signature)

Printed Name: Bill Nicholson
Title: Sr. VP Customer Svc., Transmission & Distribution

STATE OF OREGON)
) ss.
County of Multnomah)

This instrument was acknowledged before me on this 6 day of July, 2011, by Bill Nicholson, Sr. Vice President, who is the authorized agent of Portland General Electric Company.

Karen J. Lewis
Notary Public (Signature)

(stamp)



Accepted on behalf of the City of Sherwood, Oregon,

By: [Signature]
Title: City Manager

Dated this 26 day of July, 2011



**Harper
Houf Peterson
Righellis Inc.**

ENGINEERS ♦ PLANNERS
LANDSCAPE ARCHITECTS ♦ SURVEYORS

EXHIBIT "A"
LEGAL DESCRIPTION
March 18, 2011

Perpetual Public Right-of-Way Easement

A parcel of land, as shown on attached Exhibit "B", located in the Northwest and the Northeast One-Quarters of Section 29, Township 2 South, Range 1 West, of the Willamette Meridian, City of Sherwood, Washington County, Oregon, said parcel being a portion of Parcels 1 and 2 of Partition Plat No. 2003-025, a portion of Parcel 2 of Partition Plat No. 1999-085, and all of Tract "A" of Partition Plat No. 2001-048, Washington County Plat Records, being more particularly described as follows:

Beginning at a 5/8 inch iron rod with a yellow plastic cap inscribed "WRG Design Inc." at the northeast corner of Tract "A" of Partition Plat No. 2001-048, Washington County Plat Records, as shown on Preconstruction Record of Survey recorded as SN 31,601, Washington County Survey Records, said iron rod being 40.00 feet left of Proposed Centerline Station 7+11.37;

Thence S88°27'45"E, along the north line of Parcel 1 of Partition Plat No. 2003-025, Washington County Plat Records, as shown on said Survey SN 31,601, to a point 43.00 feet left of Proposed Centerline Station 10+69.62;

Thence leaving said north line, southwesterly in a straight line, to a point 38.00 feet left of Proposed Centerline Station 10+69.62, said point being the beginning of a 338.00 foot radius non-tangent curve to the right, having a central angle of 120°18'31", the radius point of which bears S09°07'16"W, 338.00 feet;

Thence southeasterly along the arc of said non-tangent curve to the right (the long chord of which bears S20°43'29"E, 586.34 feet) 709.73 feet to a point 38.00 feet left of Proposed Centerline Station 16+99.56;

Thence southwesterly, in a straight line, to a point 38.00 feet left of Proposed Centerline Station 24+04.12 and the beginning of a 362.00 foot radius curve to the left, having a central angle of 38°04'30";

Thence southwesterly along the arc of said curve to the left (the long chord of which bears S20°23'32"W, 236.16 feet) 240.56 feet to a point 38.00 feet left of Proposed Centerline Station 26+69.94;

Thence southerly, in a straight line, to a point 38.00 feet left of Proposed Centerline Station 29+53.61, and the beginning of a 531.00 foot radius curve to the left, having a central angle of 10°22'46";

Thence southeasterly along the arc of said curve to the left (the long chord of which bears S03°50'06"E, 96.06 feet) 96.19 feet to a point 46.69 feet left of Proposed Centerline Station 30+49.28 and the beginning of a 569.00 foot radius reverse curve to the right, having a central angle of 10°22'46";

Thence southeasterly along the arc of said reverse curve to the right (the long chord of which bears S03°50'06"E, 102.94 feet) 103.08 feet to a point 56.00 feet left of Proposed Centerline Station 31+51.79;

Thence southerly, in a straight line, to a point 56.00 feet left of Proposed Centerline Station 31+77.99;

Thence southeasterly, in a straight line, to a point 73.23 feet left of Proposed Centerline Station 32+65.52;

Thence southeasterly, in a straight line, to a point on the north right-of-way line of S.W. Tualatin-Sherwood Road (County Road No. 2737) as shown on said Survey SN 31,601, said point being 112.88 feet left of Proposed Centerline Station 32+93.22;

Thence N87°41'31"W, along the said north right-of-way line, 146.89 feet to a 5/8 inch iron rod with yellow plastic cap inscribed "Pelser PLS 2801" at the southwest corner of Parcel 2 of Partition Plat No. 1999-085, Washington County Plat Records, as shown on said Survey SN 31,601, said iron rod also being located on the east line of Statutory Bargain and Sale Deed to Sentinel Self Storage, LLC recorded June 6, 2005 as Document No. 2005-063362, Washington County Deed Records, and being a point 34.00 feet right of Proposed Centerline Station 32+90.77;

Thence N01°21'17"E, along the east line of said Document No. 2005-063362, to a point 34.00 feet right of Proposed Centerline Station 26+69.94 and the beginning of a 434.00 foot radius curve to the right, having a central angle of 38°04'30";

Thence northeasterly along the arc of said curve to the right (the long chord of which bears N20°23'32"E, 283.13 feet) 288.41 feet to a point 34.00 feet right of Proposed Centerline Station 24+04.12;

Thence northeasterly, in a straight line, to a point 34.00 feet right of Proposed Centerline Station 16+99.56 and the beginning of a 266.00 foot radius curve to the left, having a central angle of $127^{\circ}53'32''$;

Thence northwesterly along the arc of said curve to the left (the long chord of which bears $N24^{\circ}30'59''W$, 477.94 feet) 593.75 feet to a point 34.00 feet right of Proposed Centerline Station 10+29.92;

Thence westerly, in a straight line, to a point 34.00 feet right of Proposed Centerline Station 8+15.79;

Thence westerly, in a straight line, to a point 37.33 feet right of Proposed Centerline Station 7+15.79;

Thence westerly, in a straight line, to a point 37.33 feet right of Proposed Centerline Station 5+15.88, and the beginning of a 1015.00 foot radius curve to the right, having a central angle of $06^{\circ}13'16''$;

Thence northwesterly along the arc of said curve to the right (the long chord of which bears $N85^{\circ}21'07''W$, 110.15 feet) 110.21 feet to a point 31.61 feet right of Proposed Centerline Station 4+07.07;

Thence northerly, in a straight line, to a point on the south line of said Tract "A" of Partition Plat No. 2001-048, as shown on said Survey SN 31,601, said point being 30.00 feet right of Proposed Centerline Station 4+07.17, and the beginning of a 360.00 foot radius non-tangent curve to the left, having a central angle of $02^{\circ}07'31''$, the radius point of which bears $N03^{\circ}39'46''E$, 360.00 feet;

Thence southeasterly along the south line of said Tract "A" and the arc of said non-tangent curve to the left (the long chord of which bears $S87^{\circ}23'59''E$, 13.35 feet) 13.35 feet to a 5/8 inch iron rod with yellow plastic cap inscribed "WRG Design Inc.", said iron rod being 30.00 feet right of Proposed Centerline Station 4+19.41;

Thence $S88^{\circ}27'45''E$, along the south line of said Tract "A", 292.18 feet to a 5/8 inch iron rod with yellow plastic cap inscribed "WRG Design Inc." at the southeast corner of said Tract "A", as shown on said Survey SN 31,601, said iron rod being 30.00 feet right of Proposed Centerline Station 7+11.59;

Thence $N01^{\circ}21'17''E$, along the east line of said Tract "A", 70.00 feet to the Point of Beginning.

TOGETHER WITH all of Tract "A" of Partition Plat No. 2001-048, Washington County Plat Records, being more particularly described as follows:

Beginning at a 5/8 inch iron rod with a yellow plastic cap inscribed "WRG Design Inc." at the northeast corner of Tract "A" of Partition Plat No. 2001-048, Washington County Plat Records, as shown on Preconstruction Record of Survey recorded as SN 31,601, Washington County Survey Records, said iron rod being 40.00 feet left of Proposed Centerline Station 7+11.37;

Thence N88°27'45"W, along the north line of said Tract "A", 478.31 feet to a 5/8 inch iron rod with yellow plastic cap inscribed "WRG Design Inc." at the northwest corner of said Tract "A", as shown on said Survey SN 31,601, said iron rod being 14.71 feet right of Proposed Centerline Station 2+30.93;

Thence S43°47'30"W, along the west line of said Tract "A", 34.92 feet to a brass tack and washer inscribed "WRG Design" at the southwest corner of said Tract "A", as shown on said Survey SN 31,601, said brass tack being 49.19 feet right of Proposed Centerline Station 2+25.90;

Thence S88°18'43"E, along the south line of said Tract "A", 37.26 feet to a point 30.00 feet right of Proposed Centerline Station 2+54.44 and the beginning of a 360.00 foot radius non-tangent curve to the left, having a central angle of 28°38'38", the radius point of which bears N30°10'53"E, 360.00 feet;

Thence southeasterly along the south line of said Tract "A" and the arc of said non-tangent curve to the left (the long chord of which bears S74°08'26"E, 178.11 feet) 179.97 feet to a 5/8 inch iron rod with yellow plastic cap inscribed "WRG Design Inc.", said iron rod being 30.00 feet right of Proposed Centerline Station 4+19.41;

Thence S88°27'45"E, along the south line of said Tract "A", 292.18 feet to a 5/8 inch iron rod with yellow plastic cap inscribed "WRG Design Inc." at the southeast corner of said Tract "A", as shown on said Survey SN 31,601, said iron rod being 30.00 feet right of Proposed Centerline Station 7+11.59;

Thence N01°21'17"E, along the east line of said Tract "A", 70.00 feet to the Point of Beginning.

The parcel of land to which this description applies contains 225,754 square feet more or less.

The stationing of the Proposed Centerline of S.W. Adams Avenue is more particularly described as follows:

Beginning at Proposed Centerline Station 0+99.12, being a point on the Engineer's Centerline for the Tualatin River-Middleton Section of Pacific Highway West as shown on State Highway Drawing No. 7B-15-19 (November 1952), recorded as SN 25,639, Washington County Survey Records, said Engineer's Centerline being the same centerline described in Warranty Deed to the State of Oregon, by and through its State Highway Commission, recorded September 11, 1954 as Book of Deeds Volume 360 Pages 234-236, Washington County Deed Records, said Proposed Centerline Station 0+99.12 being located S43°47'30"W, 47.91 feet along said Engineer's Centerline from existing highway centerline station 375+79.60 as shown on Preconstruction Record of Survey recorded as SN 31,601, Washington County Survey Records;

Thence leaving said Engineer's Centerline S46°12'30"E, 76.93 feet to Proposed Centerline Station 1+76.05 and the beginning of a 330.00 foot radius curve to the left, having a central angle of 42°15'15";

Thence southeasterly along the arc of said curve to the left (the long chord of which bears S67°20'08"E, 237.89 feet) 243.36 feet to Proposed Centerline Station 4+19.41;

Thence S88°27'45"E, 610.51 feet to Proposed Centerline Station 10+29.92 and the beginning of a 300.00 foot radius curve to the right, having a central angle of 127°53'32";

Thence southeasterly along the arc of said curve to the right (the long chord of which bears S24°30'59"E, 539.03 feet) 669.64 feet to Proposed Centerline Station 16+99.56;

Thence S39°25'47"W, 704.56 feet to Proposed Centerline Station 24+04.12 and the beginning of a 400.00 foot radius curve to the left, having a central angle of 38°04'30";

Thence southwesterly along the arc of said curve to the left (the long chord of which bears S20°23'32"W, 260.95 feet) 265.82 feet to Proposed Centerline Station 26+69.94;

Thence S01°21'17"W, 667.13 feet to Proposed Centerline Station 33+37.07 and the terminus of this description, said terminus being located on the centerline of S.W. Tualatin-Sherwood Road (County Road No. 2737), being the same centerline as shown and monumented per Record of Survey recorded as SN 25,092, Washington County Survey Records and as shown on said SN 31,601.

This legal description, along with the basis of bearings thereof, is established from a preconstruction record of survey recorded as SN 31,601, Washington County Survey Records.

8.00 Foot Perpetual Public Utility Easement

A parcel of land, as shown on attached Exhibit "B", located in the Northwest and the Northeast One-Quarters of Section 29, Township 2 South, Range 1 West, of the Willamette Meridian, City of Sherwood, Washington County, Oregon, said parcel being a portion of Parcels 1 and 2 of Partition Plat No. 2003-025 and a portion of Parcel 2 of Partition Plat No. 1999-085, Washington County Plat Records, being more particularly described as follows:

Beginning at a 5/8 inch iron rod with a yellow plastic cap inscribed "WRG Design Inc." at the northeast corner of Tract "A" of Partition Plat No. 2001-048, Washington County Plat Records, as shown on Preconstruction Record of Survey recorded as SN 31,601, Washington County Survey Records, said iron rod being 40.00 feet left of Proposed Centerline Station 7+11.37;

Thence S88°27'45"E, along the north line of Parcel 1 of Partition Plat No. 2003-025, Washington County Plat Records, as shown on said Survey SN 31,601, to a point 46.00 feet left of Proposed Centerline Station 10+85.87 and the beginning of a 346.00 foot radius non-tangent curve to the right, having a central angle of 117°12'23", the radius point of which bears S12°13'24"W, 346.00 feet;

Thence southeasterly along the arc of said non-tangent curve to the right (the long chord of which bears S19°10'25"E, 590.68 feet) 707.79 feet to a point 46.00 feet left of Proposed Centerline Station 16+99.56;

Thence southwesterly, in a straight line, to a point 46.00 feet left of Proposed Centerline Station 24+04.12 and the beginning of a 354.00 foot radius curve to the left, having a central angle of 38°04'30";

Thence southwesterly along the arc of said curve to the left (the long chord of which bears S20°23'32"W, 230.94 feet) 235.25 feet to a point 46.00 feet left of Proposed Centerline Station 26+69.94;

Thence southerly, in a straight line, to a point 46.00 feet left of Proposed Centerline Station 29+53.61, and the beginning of a 523.00 foot radius curve to the left, having a central angle of 10°22'46";

Thence southeasterly along the arc of said curve to the left (the long chord of which bears S03°50'06"E, 94.61 feet) 94.74 feet to a point 54.56 feet left of Proposed Centerline Station 30+47.84 and the beginning of a 577.00 foot radius reverse curve to the right, having a central angle of 10°22'46";

Thence southeasterly along the arc of said reverse curve to the right (the long chord of which bears S03°50'06"E, 104.38 feet) 104.53 feet to a point 64.00 feet left of Proposed Centerline Station 31+51.79;

Thence southerly, in a straight line, to a point 64.00 feet left of Proposed Centerline Station 31+77.21;

Thence southeasterly, in a straight line, to a point 82.68 feet left of Proposed Centerline Station 32+72.13;

Thence southeasterly, in a straight line, to a point on the north right-of-way line of S.W. Tualatin-Sherwood Road (County Road No. 2737) as shown on said Survey SN 31,601, said point being 112.88 feet left of Proposed Centerline Station 32+93.22;

Thence N87°41'31"W, along the said north right-of-way line, 146.89 feet to a 5/8 inch iron rod with yellow plastic cap inscribed "Pelser PLS 2801" at the southwest corner of Parcel 2 of Partition Plat No. 1999-085, Washington County Plat Records, as shown on said Survey SN 31,601, said iron rod also being located on the east line of Statutory Bargain and Sale Deed to Sentinel Self Storage, LLC recorded June 6, 2005 as Document No. 2005-063362, Washington County Deed Records, and being a point 34.00 feet right of Proposed Centerline Station 32+90.77;

Thence N01°21'17"E, along the east line of said Document No. 2005-063362, 635.04 feet to a 5/8 inch iron rod with a yellow plastic cap inscribed "G&L Land Surveying Inc." at the northeast corner of said Document No. 2005-063362, as shown on said Survey SN 31,601, said iron rod also being 34.23 feet right of Proposed Centerline Station 26+56.85;

Thence N88°33'54"W, along the north line of said Document No. 2005-063362, 7.77 feet to a point 42.00 feet right of Proposed Centerline Station 26+57.07 and the

beginning of a 442.00 foot radius non-tangent curve to the right, having a central angle of $36^{\circ}13'54''$, the radius point of which bears $S86^{\circ}48'07''E$, 442.00 feet;

Thence northeasterly along the arc of said non-tangent curve to the right (the long chord of which bears $N21^{\circ}18'50''E$, 274.87 feet) 279.50 feet to a point 42.00 feet right of Proposed Centerline Station 24+04.12;

Thence northeasterly, in a straight line, to a point 42.00 feet right of Proposed Centerline Station 16+99.56 and the beginning of a 258.00 foot radius curve to the left, having a central angle of $127^{\circ}53'32''$;

Thence northwesterly along the arc of said curve to the left (the long chord of which bears $N24^{\circ}30'59''W$, 463.56 feet) 575.89 feet to a point 42.00 feet right of Proposed Centerline Station 10+29.92;

Thence westerly, in a straight line, to a point 42.00 feet right of Proposed Centerline Station 8+15.92;

Thence westerly, in a straight line, to a point 45.33 feet right of Proposed Centerline Station 7+15.92;

Thence westerly, in a straight line, to a point 45.33 feet right of Proposed Centerline Station 5+15.88, and the beginning of a 1023.00 foot radius curve to the right, having a central angle of $06^{\circ}13'16''$;

Thence northwesterly along the arc of said curve to the right (the long chord of which bears $N85^{\circ}21'07''W$, 111.02 feet) 111.08 feet to a point 39.59 feet right of Proposed Centerline Station 4+06.56;

Thence northerly, in a straight line, to a point 38.00 feet right of Proposed Centerline Station 4+06.66 and the beginning of a 368.00 foot radius non-tangent curve to the right, having a central angle of $26^{\circ}06'41''$, the radius point of which bears $N03^{\circ}45'07''E$, 368.00 feet;

Thence northwesterly along the arc of said non-tangent curve to the right (the long chord of which bears $N73^{\circ}11'32''W$, 166.26 feet) 167.71 feet to a point 38.00 feet right of Proposed Centerline Station 2+56.27;

Thence westerly, in a straight line, to a point on the southeasterly right-of-way line of S.W. Pacific Highway 99W, said point being 59.85 feet right of Proposed Centerline Station 2+24.53;

Thence northeasterly, along said right-of-way line, 10.78 feet to a brass tack and washer inscribed "WRG Design" at the southwest corner of Tract "A" of Partition Plat No. 2001-048, Washington County Plat Records, as shown on said Survey SN 31,601, said brass tack being 49.19 feet right of Proposed Centerline Station 2+25.90;

Thence S88°18'43"E, along the south line of said Tract "A", 37.26 feet to a point 30.00 feet right of Proposed Centerline Station 2+54.44 and the beginning of a 360.00 foot radius non-tangent curve to the left, having a central angle of 28°38'38", the radius point of which bears N30°10'53"E, 360.00 feet;

Thence southeasterly along the south line of said Tract "A" and the arc of said non-tangent curve to the left (the long chord of which bears S74°08'26"E, 178.11 feet) 179.97 feet to a 5/8 inch iron rod with yellow plastic cap inscribed "WRG Design Inc.", said iron rod being 30.00 feet right of Proposed Centerline Station 4+19.41;

Thence S88°27'45"E, along the south line of said Tract "A", 292.18 feet to a 5/8 inch iron rod with yellow plastic cap inscribed "WRG Design Inc." at the southeast corner of said Tract "A", as shown on said Survey SN 31,601, said iron rod being 30.00 feet right of Proposed Centerline Station 7+11.59;

Thence N01°21'17"E, along the east line of said Tract "A", 70.00 feet to the Point of Beginning.

EXCEPTING THEREFROM the above-described Parcel 1.

The parcel of land to which this description applies contains 37,254 square feet more or less.

The stationing used to describe this parcel is based on the Proposed Centerline of Adams Avenue described herein, being more particularly described in Parcel 1.

Perpetual Storm Drainage Easement

A parcel of land, as shown on attached Exhibit "B", located in the Northeast One-Quarter of Section 29, Township 2 South, Range 1 West, of the Willamette Meridian, City of Sherwood, Washington County, Oregon, said parcel being a portion of Parcel 2

of Partition Plat No. 2003-025, Washington County Plat Records, being more particularly described as follows:

Beginning at a point 38.00 feet left of Proposed Centerline Station 17+73.72;

Thence southeasterly, in a straight line, to a point 64.70 feet left of Proposed Centerline Station 17+84.27;

Thence easterly, in a straight line, to the intersection with the northerly extension of the west line of the Plat of "Sherwood Commercial Center", Washington County Plat Records, as shown on Preconstruction Record of Survey recorded as SN 31,601, Washington County Survey Records, said point being 150.40 feet left of Proposed Centerline Station 17+18.38;

Thence southerly, along said west line and the northerly extension thereof, to a point 213.98 feet left of Proposed Centerline Station 17+99.45;

Thence leaving said west line southwesterly, in a straight line, to a point 165.11 feet left of Proposed Centerline Station 18+90.59;

Thence northwesterly, in a straight line, to a point 38.00 feet left of Proposed Centerline Station 18+40.38;

Thence northeasterly, in a straight line, to a point 38.00 feet left of Proposed Centerline Station 17+73.72 and the point of beginning of the tract herein described.

The parcel of land to which this description applies contains 17,868 square feet more or less.

The stationing used to describe this parcel is based on the Proposed Centerline of Adams Avenue described herein, being more particularly described in Parcel 1.

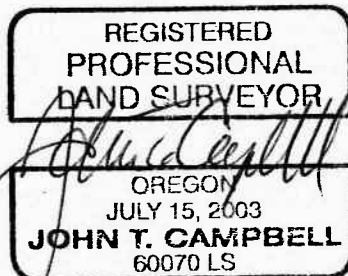

12-31-11

EXHIBIT "B"

MARCH 18, 2011

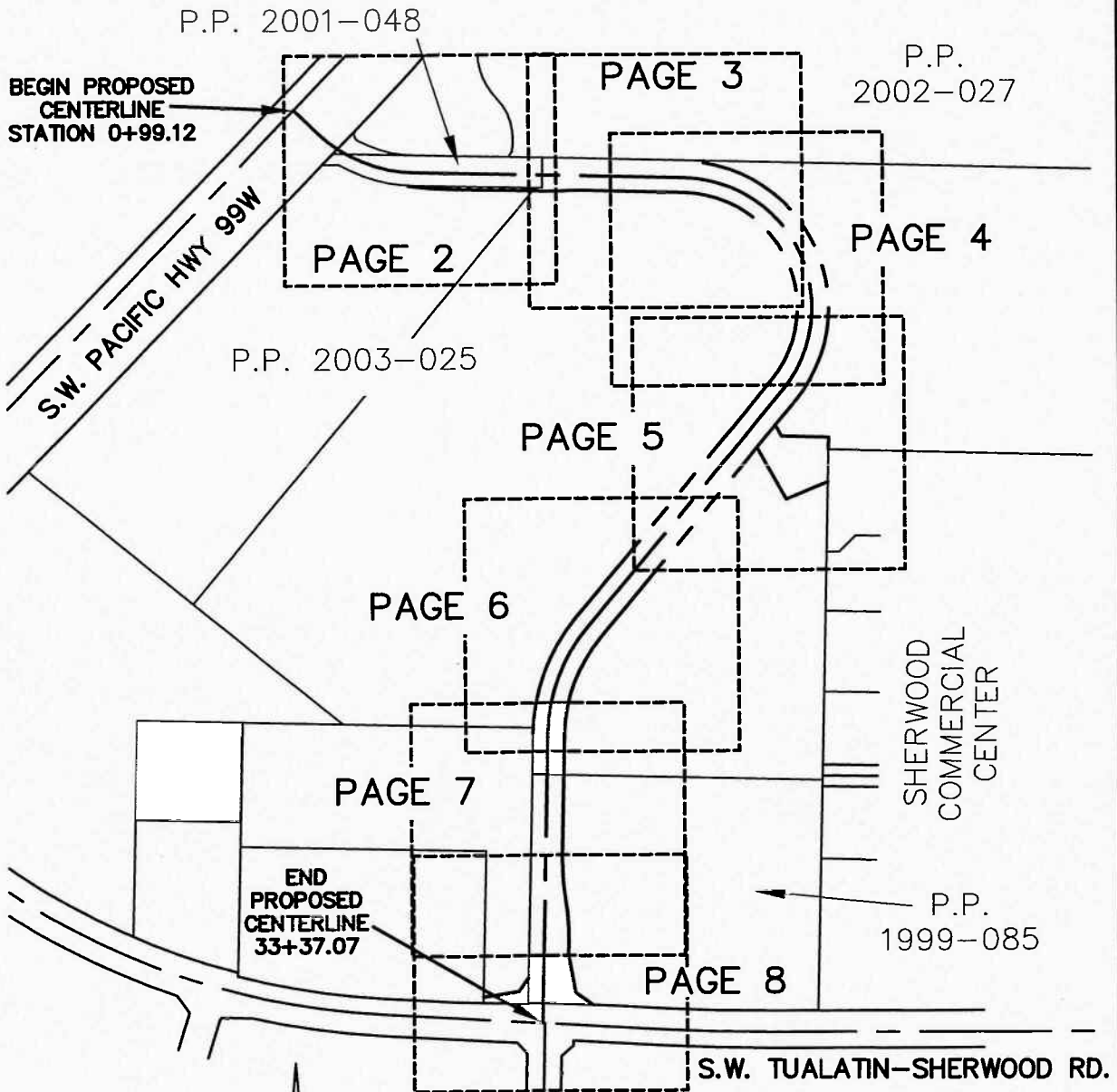

1" = 400'



**Harper
Houf Peterson
Righellis Inc.**

ENGINEERS • PLANNERS
LANDSCAPE ARCHITECTS SURVEYORS

205 SE SPOKANE STREET, SUITE 200, PORTLAND, OR 97202
TEL 503.221.1131 www.hhpr.com FAX 503.221.1171

EXHIBIT PAGE 1 OF 8

EXHIBIT "B"
MARCH 18, 2011



1" = 100'

PARCEL 1
P.P. 2002-027

POINT OF BEGINNING
PARCELS 1
AND 2
7+11.37
40.00 LT.

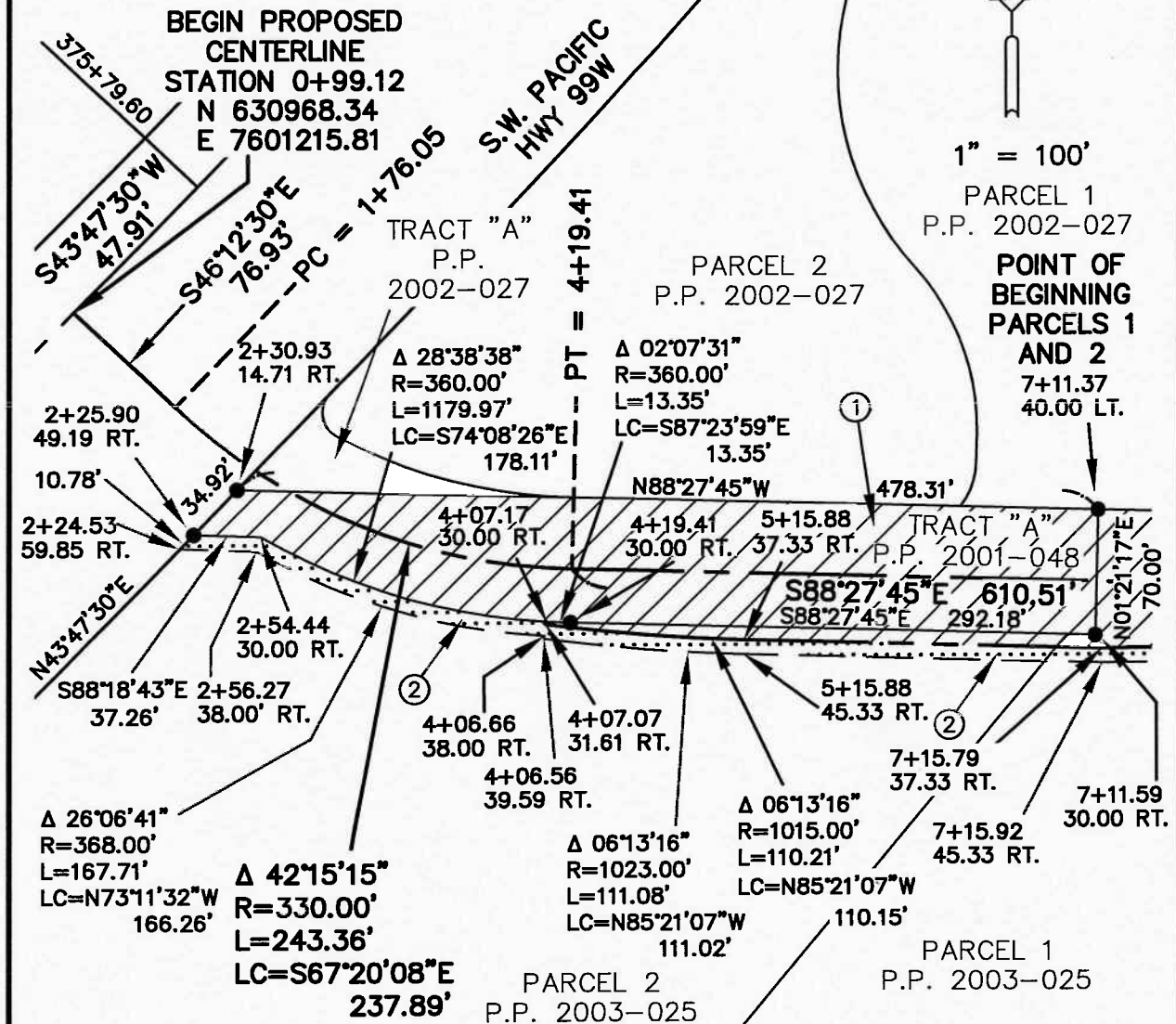

LEGEND



① PERPETUAL PUBLIC R.O.W. EASEMENT
± 225,754 SQ.FT.

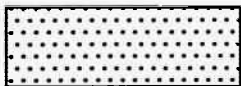

② 8.00 FOOT PERPETUAL PUBLIC UTILITY EASEMENT
± 37,254 SQ.FT.

● - FOUND SURVEY MONUMENT



Harper
Houf Peterson
Righellis Inc.

ENGINEERS • PLANNERS
LANDSCAPE ARCHITECTS SURVEYORS

205 SE SPOKANE STREET, SUITE 200, PORTLAND, OR 97202
TEL 503.221.1131 www.hhpr.com FAX 503.221.1171

EXHIBIT PAGE 2 OF 8

EXHIBIT "B"
 MARCH 18, 2011



1" = 100'

TRACT "A"
 P.P. 2001-048

PARCEL 1
 P.P. 2002-027

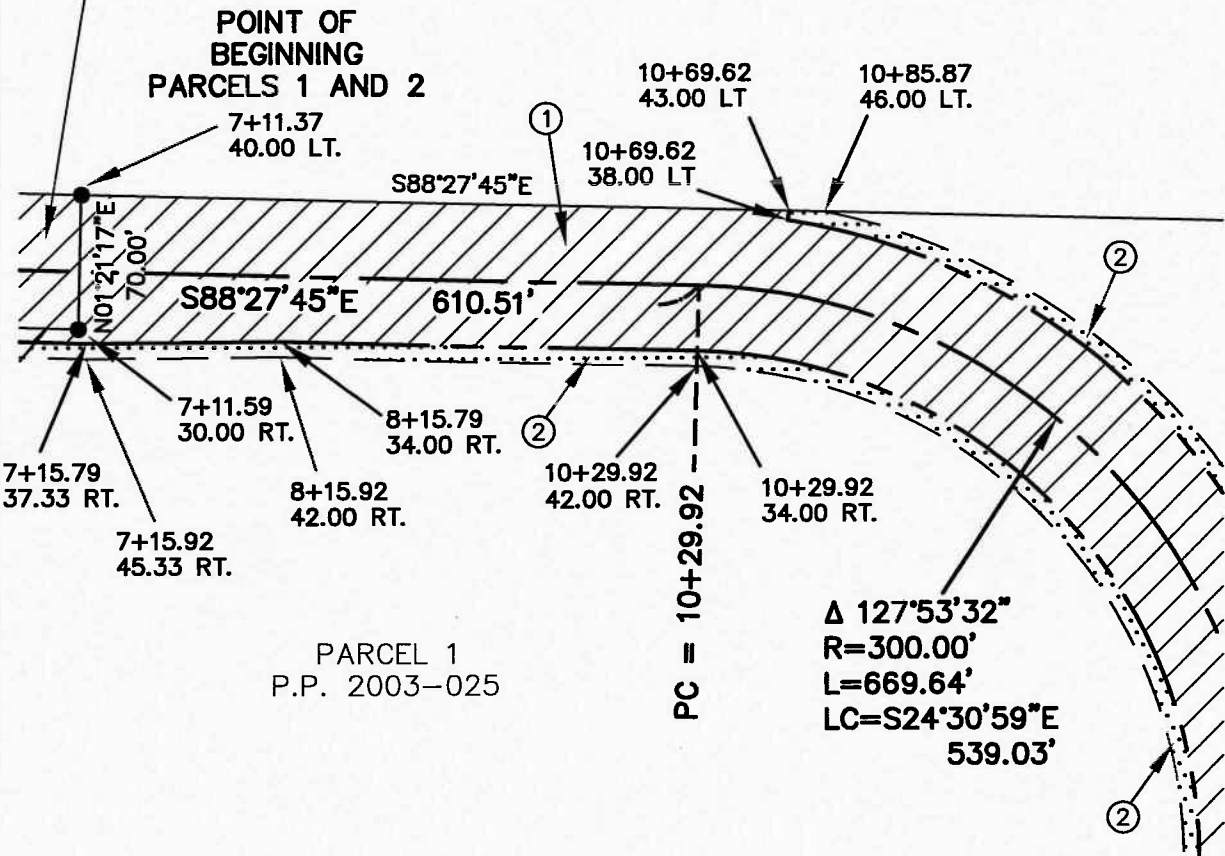

LEGEND



① PERPETUAL PUBLIC R.O.W. EASEMENT ± 225,754 SQ.FT.

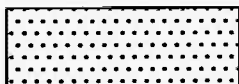

② 8.00 FOOT PERPETUAL PUBLIC UTILITY EASEMENT ± 37,254 SQ.FT.

● - FOUND SURVEY MONUMENT



**Harper
 Houf Peterson
 Righellis Inc.**

ENGINEERS • PLANNERS
 LANDSCAPE ARCHITECTS SURVEYORS

205 SE SPOKANE STREET, SUITE 200, PORTLAND, OR 97202
 TEL 503.221.1131 www.hhpr.com FAX 503.221.1171

EXHIBIT "B"

MARCH 18, 2011

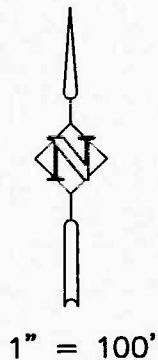
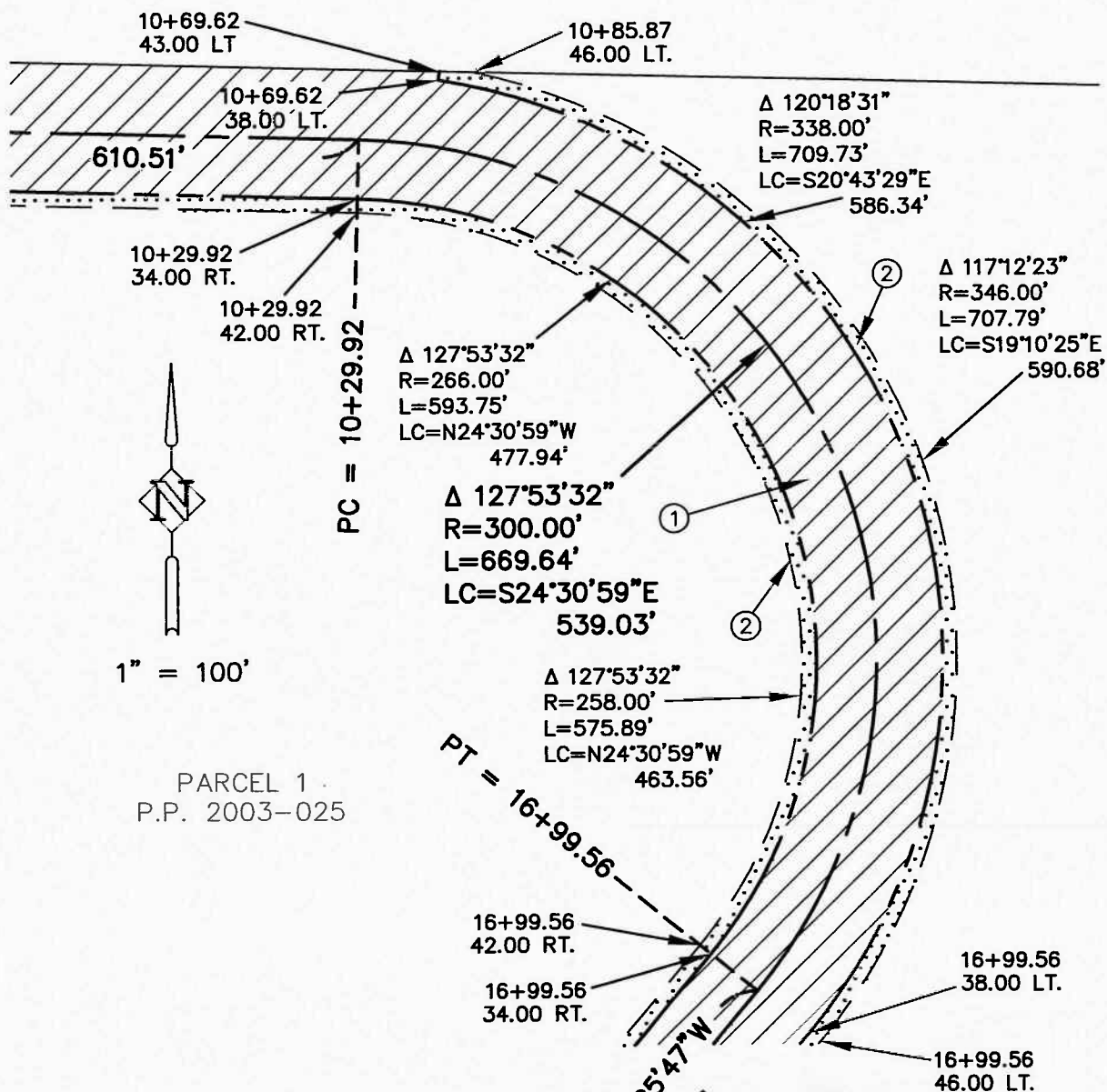

PARCEL 1
P.P. 2003-025

LEGEND



① PERPETUAL PUBLIC R.O.W. EASEMENT
± 225,754 SQ.FT.



② 8.00 FOOT PERPETUAL PUBLIC UTILITY EASEMENT
± 37,254 SQ.FT.



**Harper
Houf Peterson
Righellis Inc.**

ENGINEERS • PLANNERS
LANDSCAPE ARCHITECTS SURVEYORS

205 SE SPOKANE STREET, SUITE 200, PORTLAND, OR 97202
TEL 503.221.1131 www.hhpr.com FAX 503.221.1171

EXHIBIT PAGE 4 OF 8

EXHIBIT "B"

MARCH 18, 2011



1" = 100'

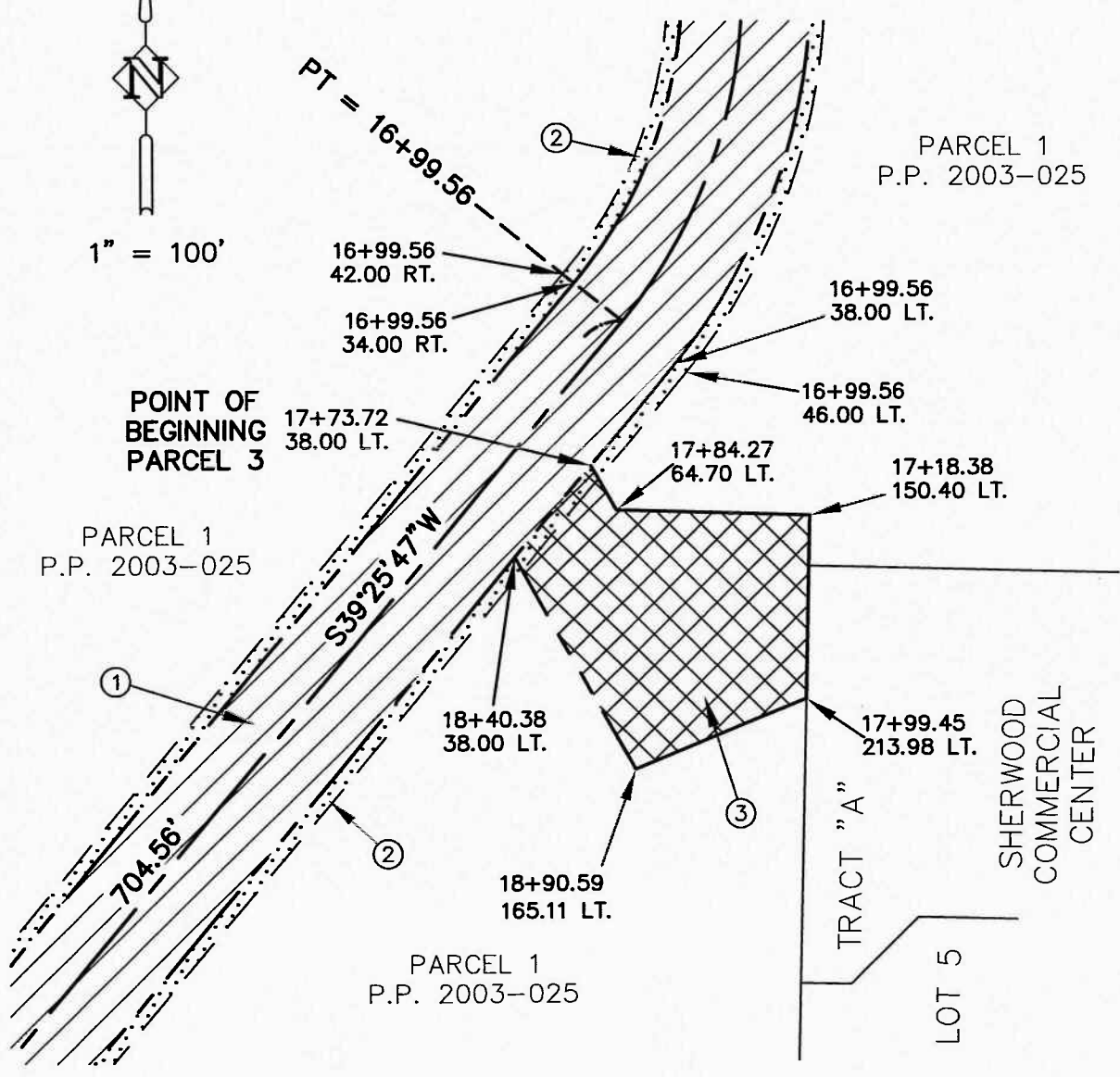

LEGEND



① PERPETUAL PUBLIC R.O.W. EASEMENT ± 225,754 SQ.FT.



② 8.00 FOOT PERPETUAL PUBLIC UTILITY EASEMENT ± 37,254 SQ.FT.



③ PERPETUAL STORM DRAINAGE EASEMENT ± 17,868 SQ.FT.



**Harper
Houf Peterson
Righellis Inc.**

ENGINEERS • PLANNERS
LANDSCAPE ARCHITECTS SURVEYORS

205 SE SPOKANE STREET, SUITE 200, PORTLAND, OR 97202
TEL 503.221.1131 www.hhpr.com FAX 503.221.1171

EXHIBIT PAGE 5 OF 8

EXHIBIT "B"

MARCH 18, 2011



1" = 100'

PARCEL 1
P.P. 2003-025

PARCEL 1
P.P. 2003-025

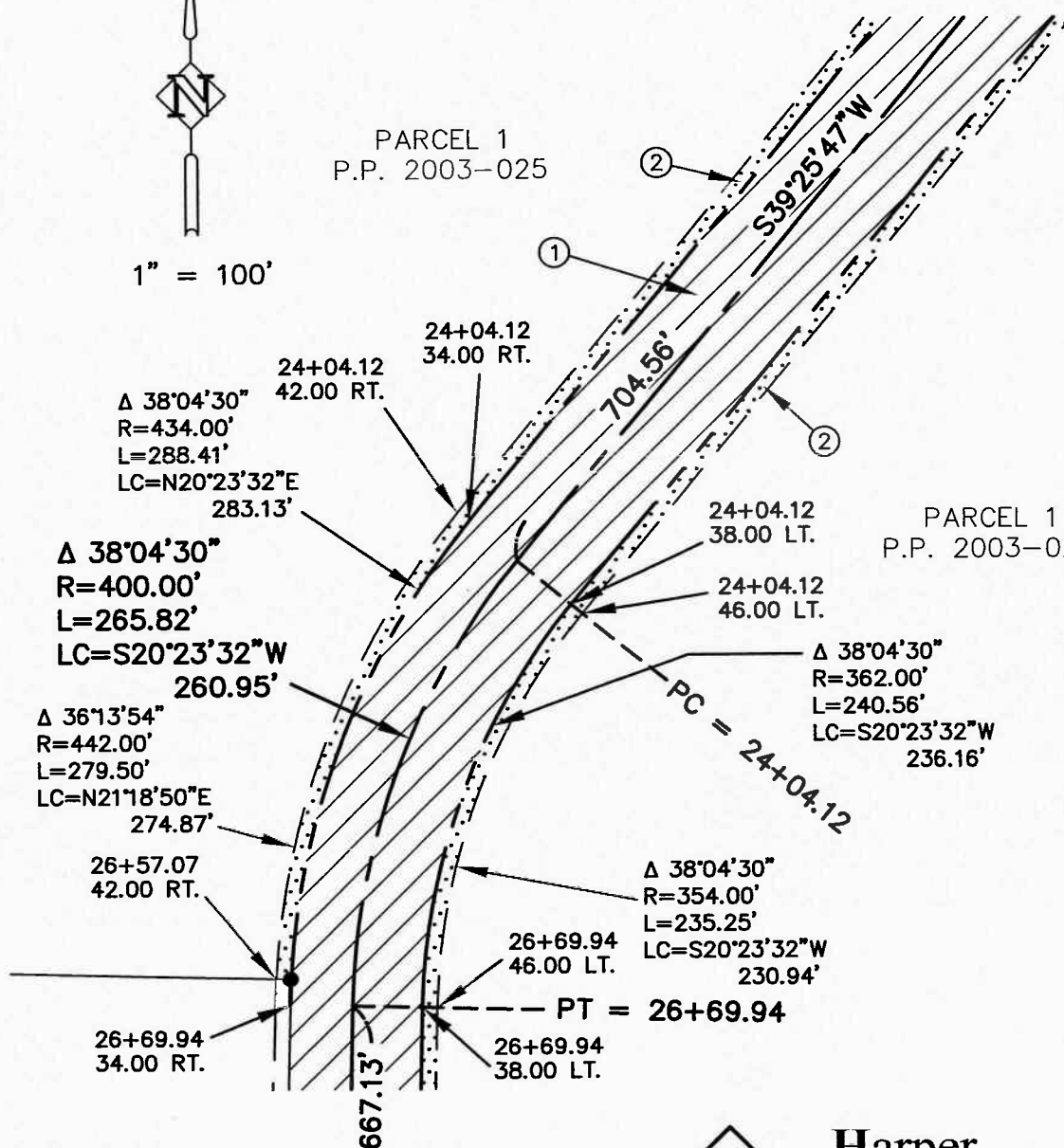

LEGEND



① PERPETUAL PUBLIC R.O.W. EASEMENT ± 225,754 SQ.FT.



② 8.00 FOOT PERPETUAL PUBLIC UTILITY EASEMENT ± 37,254 SQ.FT.

● - FOUND SURVEY MONUMENT



**Harper
Houf Peterson
Righellis Inc.**

ENGINEERS • PLANNERS
LANDSCAPE ARCHITECTS SURVEYORS

205 SE SPOKANE STREET, SUITE 200, PORTLAND, OR 97202
TEL 503.221.1131 www.hhpr.com FAX 503.221.1171

EXHIBIT PAGE 6 OF 8

EXHIBIT "B"

MARCH 18, 2011

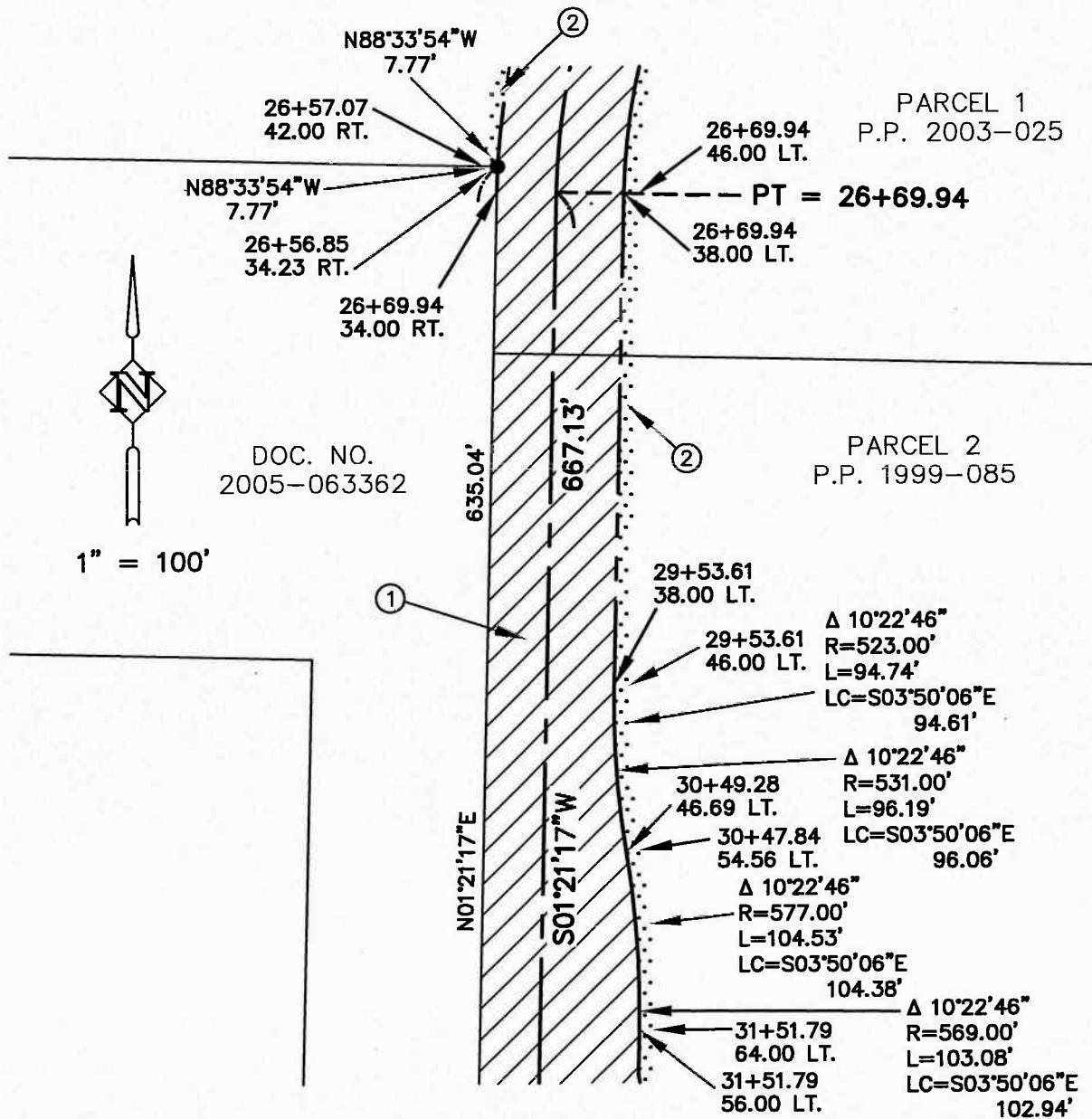

LEGEND



① PERPETUAL PUBLIC R.O.W. EASEMENT
± 225,754 SQ.FT.

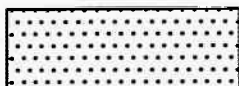

② 8.00 FOOT PERPETUAL PUBLIC UTILITY EASEMENT
± 37,254 SQ.FT.

● - FOUND SURVEY MONUMENT



**Harper
Houf Peterson
Righellis Inc.**

ENGINEERS • PLANNERS
LANDSCAPE ARCHITECTS SURVEYORS

205 SE SPOKANE STREET, SUITE 200, PORTLAND, OR 97202
TEL 503.221.1131 www.hhpr.com FAX 503.221.1171

EXHIBIT PAGE 7 OF 8

EXHIBIT "B"

MARCH 18, 2011

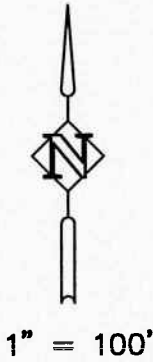

DOC. NO.
2005-063362

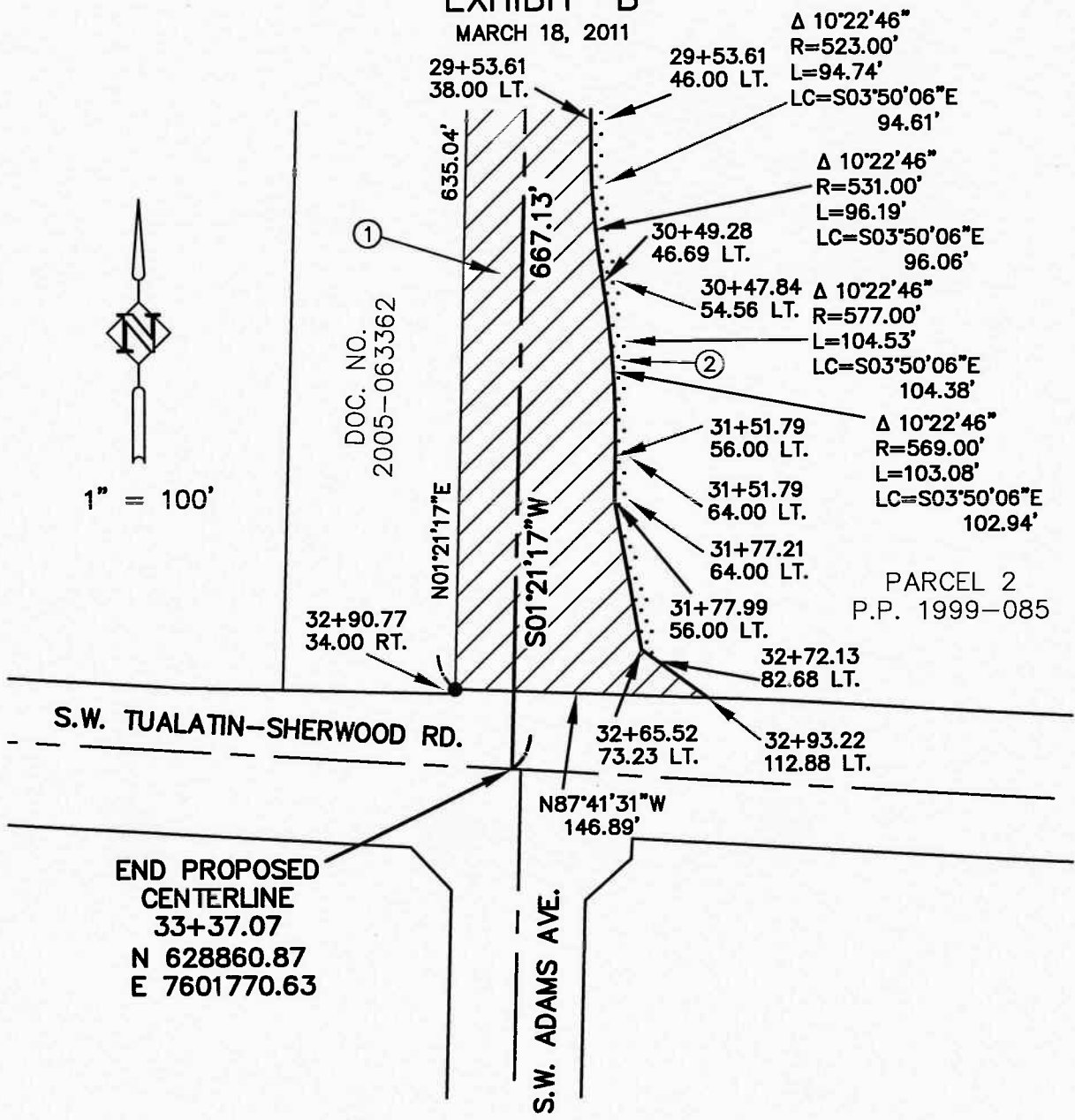

LEGEND

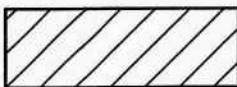

① PERPETUAL PUBLIC R.O.W. EASEMENT
± 225,754 SQ.FT.

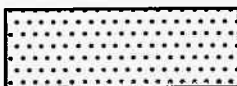

② 8.00 FOOT PERPETUAL PUBLIC UTILITY EASEMENT
± 37,254 SQ.FT.

● - FOUND SURVEY MONUMENT



**Harper
Houf Peterson
Righellis Inc.**

ENGINEERS • PLANNERS
LANDSCAPE ARCHITECTS SURVEYORS

205 SE SPOKANE STREET, SUITE 200, PORTLAND, OR 97202
TEL 503.221.1131 www.hhpr.com FAX 503.221.1171

EXHIBIT PAGE 8 OF 8