



State of Oregon
**Department of
Environmental
Quality**

Equipment and Components

CARB Executive Order VR-101-V

Franklin Fueling Systems, Inc.
Phil-Tite/EBW/FFS
Stage I Enhanced Vapor Recovery System

EXHIBIT 1

Franklin Fueling Systems (Phil-Tite/EBW/FFS) Stage I EVR System Equipment List NOTE:

(Gas/E85) = Identifies that these components are approved for standard gasoline and E85 fuel blends. (Gas) = Identifies that these components are only approved for standard gasoline fuel blends.

Equipment

**Spill Container
(Phil-Tite Series
Spill Containers)**

Manufacturer/Model Number

Phil-Tite 85000 and 85000-1 Series (Gas/E85)

85W0X and 85W0X-1 legend:

W represented by:

1=replacement spill container

X represented by:

0 = product spill container

0-EXT = product spill container w extension collar

1 = vapor spill container

1-EXT = vapor spill container w extension collar

**Spill Container
(Defender Series
Spill Containers)**

EBW Defender 705 Series (Gas/E85)

Defender 705 Series Legend (Gas/E85)

7055XYZAB where XYZAB is represented by:

X = containment

4 = single wall

5 = double wall

Y = installation

2 = multiport bucket

5 = direct bury

Z = interstitial monitoring method

0 = no sensor/gauge (i.e. single wall)

1 = I2 monitor (float gauge, visual)

2 = TSP-ULS (electronic sensor)

A = spill container base thread

0 = NPSM (straight thread)

1 = NPT (taper thread)

B = drain valve

1 = with drain valve (typical on product/fill side)

2 = without drain valve (typical on vapor side)

**Spill Container
(EBW Series Spill
Containers)**

EBW 7XX-49Y-0Z (Gas)

XX indicates spill bucket gallon size:

05 = 5 Gallon

15 = 15 Gallon

Y indicates level and base material:

0 = grade level with cast iron base (5 gallon)

2 = below grade level with cast iron base
(5 and 15 gallon)

Z indicates drain valve:

Exhibit 1 (Continued)

<u>Equipment</u>	<u>Manufacturer/Model Number</u>	
		1 = drain valve 2 = no drain valve
Spill Container Lid (Phil-Tite Series Spill Containers)	Phil-Tite	85011 (Gas/E85) (Not required with sump configuration lid, see Figure 2B in Exhibit 2)
Spill Container Lid (Defender and EBW Series Spill Containers)	EBW	7054401X (Gas/E85) X = Lid Color, Varies
Replacement Drain Valve (Phil-Tite Series Spill Containers)	Phil-Tite	85400 (Gas/E85)
Replacement Drain Valve (Defender Series Spill Containers)	EBW	70533729 (Gas/E85)
Replacement Drain Valve (EBW Series Spill Container)	EBW	70533719 (Gas) 70533729 (Gas/E85)
Drain Valve Blank Kit (EBW Series Spill Container)	EBW	90022
Drain Valve Isolation Kit (EBW Series Spill Containers)	EBW	70825501
Drain Valve Isolation Test Kit (EBW Series Spill Containers)	EBW	90079
Product Adaptor	Phil-Tite	SWF-100-B (Gas) Phil-Tite SWF-100-SS (Gas/E85)
Vapor Adaptor	Phil-Tite	SWV-101-B (Gas) Phil-Tite SWV-101-SS (Gas/E85)
Riser Adaptor	Phil-Tite	M/F 4X4 (Gas/E85) Phil-Tite M/F 4X4-R (Gas/E85)
Riser Support Bracket	Phil-Tite	M 1600 (Gas/E85)

Exhibit 1 (Continued)

<u>Equipment</u>	<u>Manufacturer/Model Number</u>
Drop Tube Riser Clamp (Defender Series Spill Containers)	FFS 70550901EC (Gas/E85)
Dust Cap	Morrison Brothers 323C-0100ACEVR (vapor) (Gas/E85) Morrison Brothers 305C-0100ACEVR (product)(Gas/E85)
	OPW 1711T-EVR (vapor) (Gas/E85) OPW 634TT-EVR (product) (Gas/E85) OPW 634LPC (product) (Gas) OPW 1711LPC (vapor) (Gas)
	CompX CSP1-634LPC (product) (Gas) CompX CSP3-1711LPC (vapor) (Gas) CompX CSP2-634LPC (product) (Gas) CompX CSP4-1711LPC (vapor) (Gas)
	EBW 77720102 (product) (Gas/E85) EBW 77720202 (product) (Gas/E85) EBW 30430103 (vapor) (Gas/E85) EBW 30420006 (vapor) (Gas/E85)
Pressure/Vacuum Vent Valve	FFS PV-Zero 407215901 (Gas/E85) Husky 5885 (Gas/E85) OPW 723V (Gas/E85)
Tank Gauge Port Components	Veeder-Root 312020-952 (cap and adaptor kit) (Gas/E85)
	Morrison Brothers 305XPA1100AKEVR (cap and adaptor kit) (Gas/E85) Morrison Brothers 305-0200AAEVR (replacement adaptor) (Gas/E85) Morrison Brothers 305XP-110ACEVR (replacement cap) (Gas/E85)
	EBW 90037-E (In Tank Probe Cap and Adapter Kit) (Gas/E85)
Drop Tube Overfill Prevention Device¹	Defender Series OPV 70859X9YZ (Gas/E85) Defender Series OPV 70869X9YZ (Gas/E85)

Defender Series OPV legend:

X = upper drop tube length:

1 = 5 feet

2 = 10 feet

Y = Tube compatibility:

0 = Gas

2 = Gas/E85

Z = lower drop tube length:

1 = 8 feet

2 = 10 feet

Exhibit 1 (Continued)

<u>Equipment</u>	<u>Manufacturer/Model Number</u>
	EBW 70849X1Y (Gas)
	EBW 70849X3Y (Gas/E85)
	X represented by: 1 = 5 foot length upper drop tube section 2 = 10 foot length upper drop tube section
	Y represented by: 1 = 8 foot length bottom thread on section drop tube 2 = 10 foot length bottom thread on section drop tube
Drop Tube¹	OPW 61-T (various lengths) (Gas)(Phil-Tite Series Spill Containers only)
	EBW 7822041X-2 (X = various lengths) (Gas)
	EBW 7822043X-2 (X = various lengths) (Gas/E85)
Riser Offset¹	Phil-Tite M-6050-X (x = various offsets) (Gas/E85)
Double Fill¹ Tank Riser Configuration	Phil Tite (configuration only) (Gas/E85) Defender (configuration only) (Gas/E85)
Tank Bottom Protector¹	Phil-Tite TBP-3516-E (Gas/E85)
Emergency Vent	Exhibit 5 (for below-grade vaulted tank configuration)
Fuel Lock¹	McGard FL1 – Stick Only Fuel Lock (125007) (Gas) McGard FL2 – Stick/Sampling Fuel Lock (125008) (Gas)
Bladder Plug	McGard PSI104 (Gas)

¹ If these components are installed or required by regulations of other agencies, only those components and model numbers specified above shall be installed or used.

Exhibit 1 (Continued)

**Table 1
Components Exempt from Identification Requirements**

Component Name	Manufacturer	Model Number
Drop Tube	OPW EBW EBW	61-T Straight Drop Tube (Gas) 7822041X-2 (X = various lengths) (Gas) 7822043X-2 (X = various lengths) (Gas/E85)
Dust Caps	Morrison Brothers	323C-0100ACEVR (vapor)* (Gas/E85) 305C-0100ACEVR (product)* (Gas/E85)
Tank Gauge Port Components	Veeder-Root	312020-952 (cap & adaptor) (Gas/E85)
	Morrison Brothers	305XPA1100AKEVR (cap and adaptor kit) (Gas/E85) 305-0200AAEVR (replacement adaptor) (Gas/E85) 305XP-1100ACEVR (replacement cap) (Gas/E85)
	EBW	90037-E (In Tank Probe Cap and Adaptor Kit) (Gas/E85)
Riser Adaptor	Phil-Tite	M/F 4X4 (Gas/E85) M/F 4X4-R (Gas/E85)
Riser Offset	Phil-Tite	M-6050-X (X = various offsets) (Gas/E85)
Riser Support Bracket	Phil-Tite	M-1600 (Gas/E85)
Spill Container Lid	Phil-Tite EBW	85011 (Gas/E85) 7054401X (Gas/E85)
Sump/Sump Lids	Varies	Varies (Gas/E85)
Drop Tube Riser Clamp	FFS	70550901EC (Gas/E85)
Replacement Drain Valve	EBW	EBW 70533729 EBW 70533719
Drain Valve Blank Kit	EBW	90022
Fuel Lock	McGard	FL1, FL2

* Morrison Brothers dust caps identified as 323C EVR and 305C EVR respectively.

The component in Table 2 may not be installed as a new or replacement part on or after September 1, 2002. This component, if installed prior to September 1, 2002, may be used for the remainder of its useful life.

Table 2

Component Name	Manufacturer	Model Number
Drop Tube	Emco Wheaton	A0020 (various lengths) (Gas)

Component Identification and Location

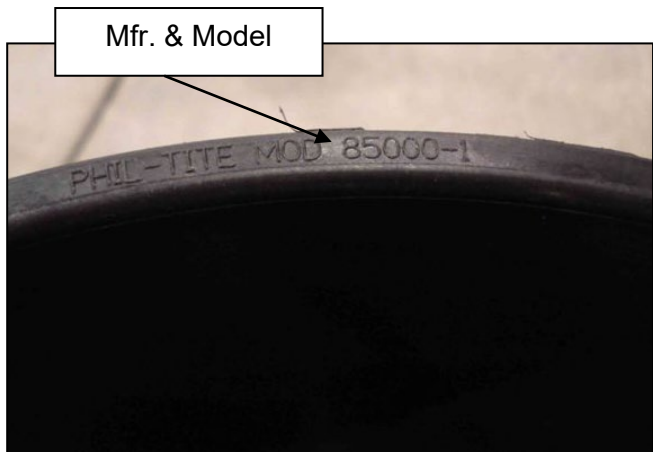

Phil-Tite Model 85000 Series Spill Containers

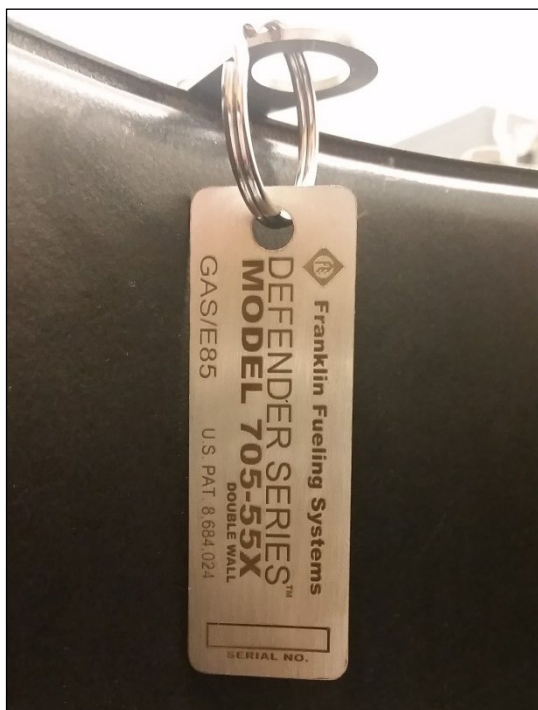

**Defender 705 Series Spill Container-
double wall (Gas/E85 Compatible)**

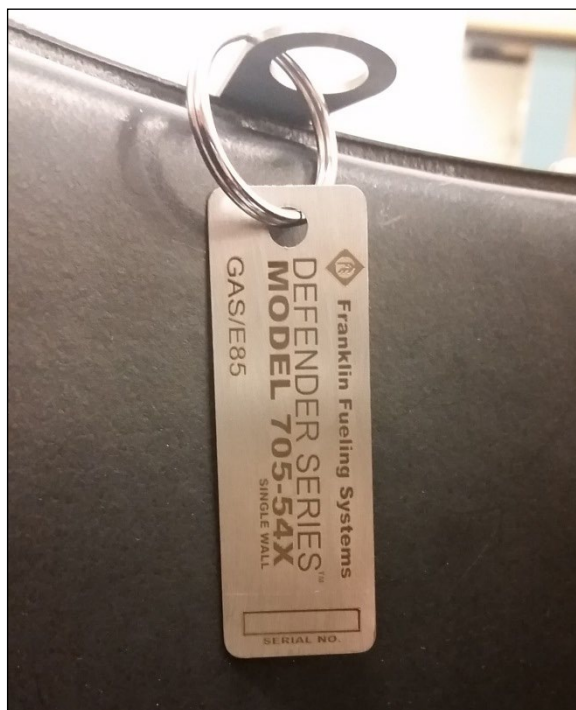

**Defender 705 Series Spill Container-
single wall (Gas/E85 Compatible)**

Component Identification and Location



(New Tag Front) Defender Series Spill Container (Gas/E85 Compatible)

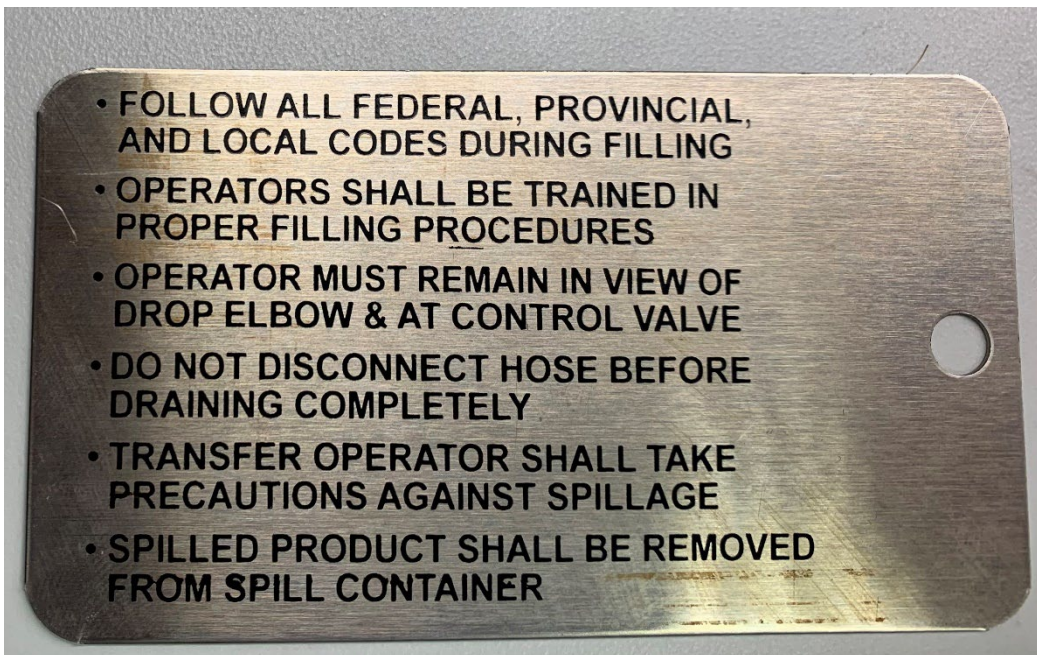

(New Tag Back) Defender Series Spill Container (Gas/E85 Compatible)

Exhibit 1 (Continued)

Component Identification and Location



Spill Container EBW 7XX-49Y-0Z

Exhibit 1 (Continued)

Component Identification and Location

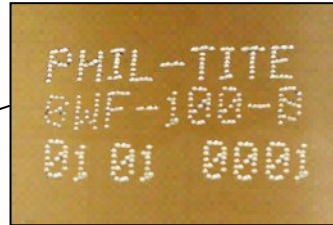

**Phil-Tite Model SWF-100-B
Product Adaptor**

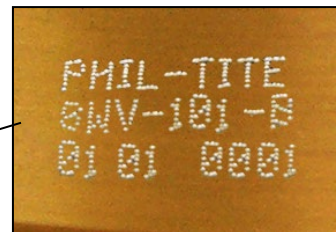

**Phil-Tite Model SWV-101-B
Vapor Adaptor**

Component Identification and Location



Phil-Tite SWF-100-SS Fill Adaptor



Phil-Tite SWF-101-SS Fill Adaptor

Exhibit 1 (Continued)

Component Identification and Location

FFS PV-Zero P/V Vent Valve (Gas/E85)
(Model and Serial Number on White Tag)



OPW 723V P/V Vent Valve (Gas/E85)

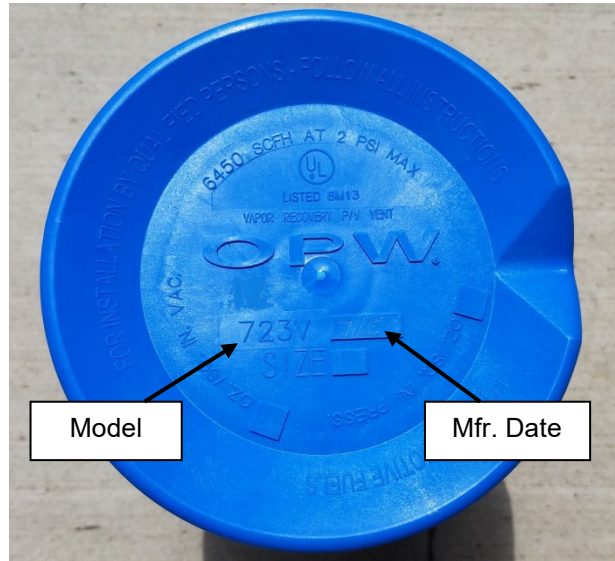

Husky 5885 P/V Vent Valve (Gas/E85)
(Husky Name on Bottom Flange)

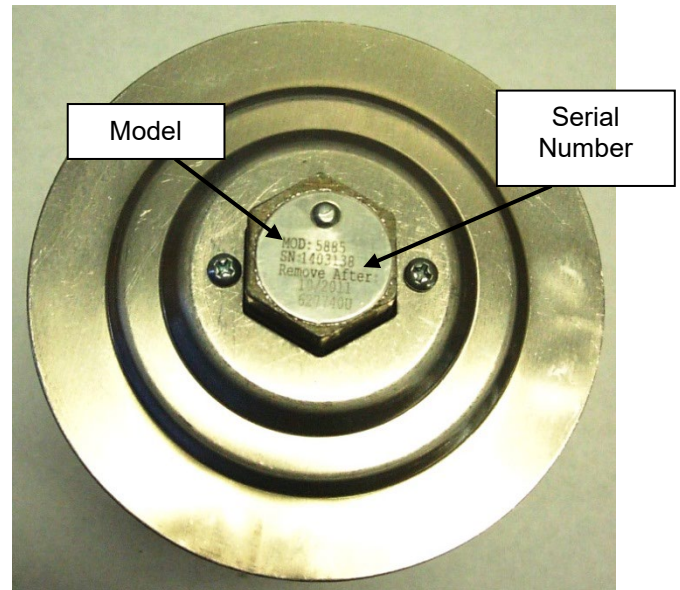

Exhibit 1 (Continued)

Component Identification and Location



EBW Model 70849X1Y Overfill Prevention Device
(Gas Compatible)



EBW 70849X3Y Autolimiter
(Gas/E85 Compatible)

Exhibit 1 (Continued)

Component Identification and Location



**Defender OPV series 70859X9YZ
(Gas/E85 compatible)**

Exhibit 1 (Continued)

Component Identification and Location



**Defender OPV series 70869X9YZ
(Gas/E85 compatible)**

Component Identification and Location

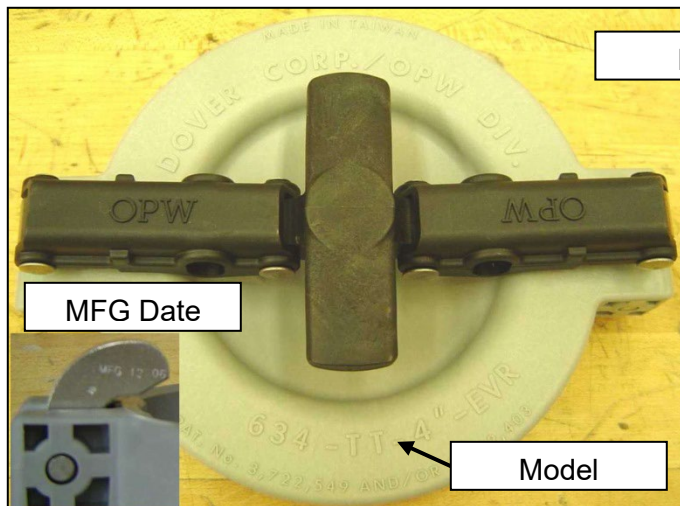

OPW 634-TT-EVR Product Dust Cap
(Gas/E85 Compatible)

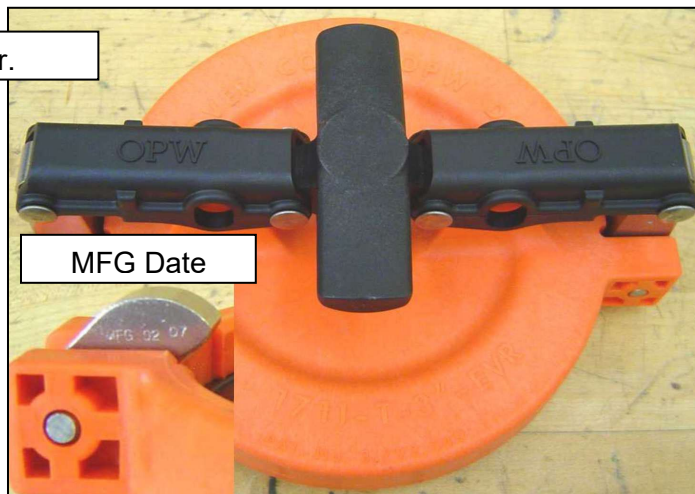

OPW 1711-T-EVR Vapor Dust Cap
(Gas/E85 Compatible)



OPW 634LPC Product Dust Cap
(Gas Compatible)



OPW 1711LPC Vapor Dust Cap
(Gas Compatible)

Exhibit 1 (Continued)

Component Identification and Location



EBW 77720102 Product Dust Cap
(Gas/E85)



EBW 30430103 Vapor Dust Cap
(Gas/E85)

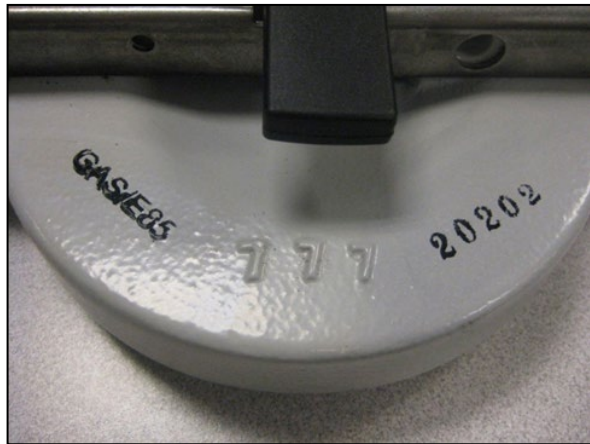

EBW 77720202 Product Dust Cap
(Gas/E85 Compatible)



EBW 30420006 Vapor Dust Cap
(Gas/E85)

Exhibit 1 (Continued)

Component Identification



**Morrison Brothers 323C EVR
Vapor Dust Cap
(Gas/E85 Compatible)**



**Morrison Brothers 305C EVR
Product Dust Cap
(Gas/E85 Compatible)**

Component Identification and Location

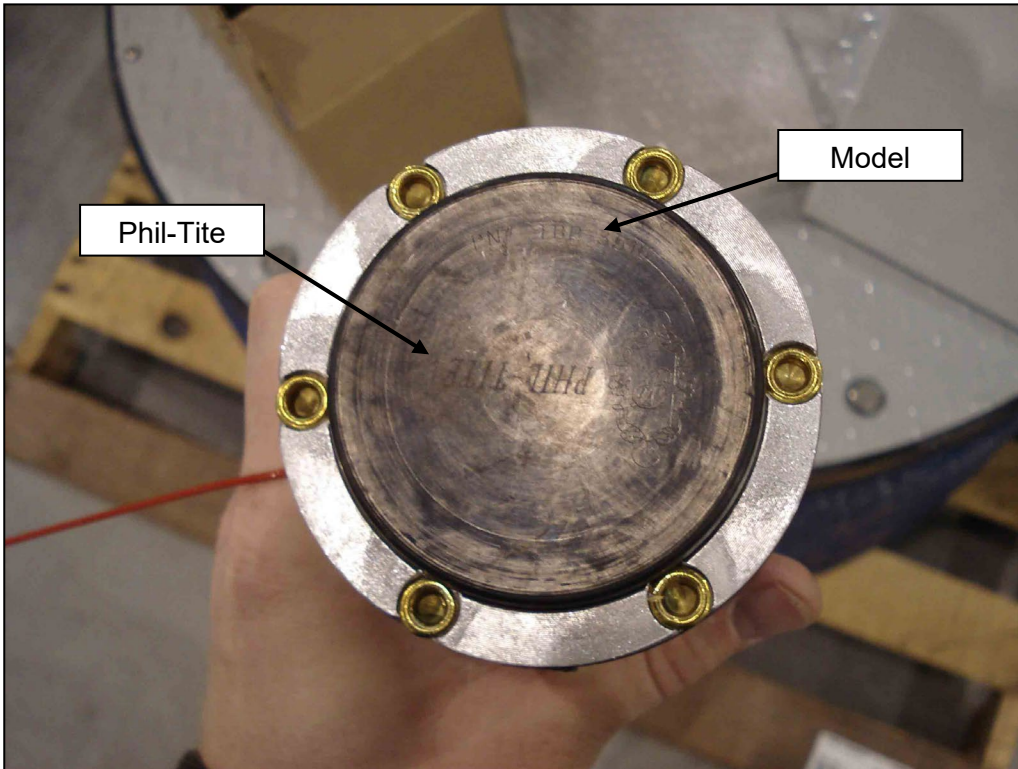

Phil-Tite TBP-3516-E (Gas/E85) Series Tank Bottom Protector

Exhibit 1 (Continued)

Component Identification and Location

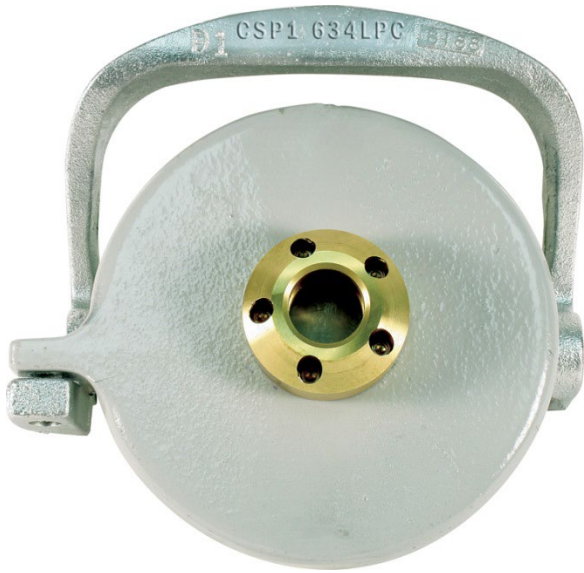

CompX CSP1-634LPC Product Dust Cap



CompX CSP3-1711LPC Vapor Dust Cap
(Gas Only)



CompX Tank Commander Lid
Locks onto CSP1-634LPC and CSP3-1711LPC Dust Caps

Exhibit 1 (Continued)

Component Identification and Location

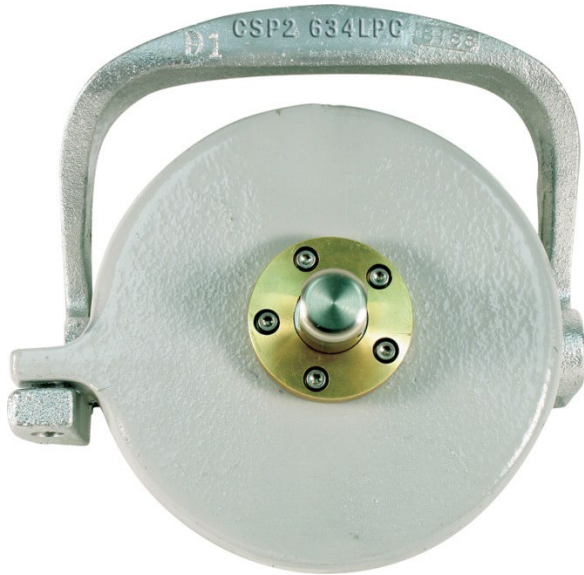

CompX CSP2-634LPC Product Dust Cap



CompX CSP4-1711LPC Vapor Dust Cap
(Gas Only)



CompX Tank Commander Lid
Locks onto CSP2-634LPC and CSP4-1711LPC Dust Caps

Exhibit 1 (Continued)

Component Identification and Location



McGard Fuel Lock Installation Position¹



McGard Fuel Lock (FL1 on Left, FL2 on Right)

¹ Optional component, but if installed this picture shows the correct installation location in the pipe just below the Product Rotatable Adaptor in the drop tube.

Exhibit 2

Installation, Maintenance and Compliance Specifications

This Exhibit contains the installation, maintenance and compliance standards and specifications applicable to the Franklin Fueling System (FFS) stage I Enhanced Vapor Recovery system installed in a gasoline dispensing facility (GDF). Table 2-1 summarizes the compliance standard and specification with the corresponding test method. Table 2-2 describes the maintenance interval for the FFS stage I EVR system components.

General Specifications

1. Typical installations of the FFS stage I EVR system and system components are shown in Figures 2A through 2N of the full CARB Executive Order.
2. The FFS stage I EVR system shall be installed, operated and maintained in accordance with this attachment, applicable Oregon Administrative Rules, and manufacturer's specifications.
3. Any repair or replacement of system components shall be done in accordance with this attachment, applicable Oregon Administrative Rules, and manufacturer's specifications.
4. Unless otherwise specified in this attachment or Oregon Administrative Rule, the FFS stage I EVR system shall comply with the applicable performance standards and performance specifications in CP-201.
5. Installation, maintenance and repair of system components, including removal and installation of such components in the course of any required tests, shall be performed in accordance with this attachment, applicable Oregon Administrative Rules, and manufacturer's specifications.

Pressure/Vacuum Vent Valves For Storage Tank Vent Pipes

1. No more than three certified pressure/vacuum vent valves (P/V valves) listed in Exhibit 1 shall be installed on any GDF underground storage tank system.
2. Compliance determination of the following P/V valve performance specifications shall be at the option of the owner or operator:
 - a. The leak rate of each P/V valve shall not exceed 0.05 cubic feet per hour (CFH) at 2.00 inches of H₂O positive pressure and 0.21 CFH at -4.00 inches of H₂O negative pressure as determined by TP-201.1E, Leak Rate and Cracking Pressure of Pressure/Vacuum Vent Valves.
 - b. The positive pressure setting is 2.5 to 6.0 inches of H₂O and the negative pressure setting is 6.0 to 10.0 inches of H₂O as determined by TP-201.1E, Leak Rate and Cracking Pressure of Pressure/Vacuum Vent Valves.
3. Compliance determination of the P/V valve performance specifications in items 2a and 2b for the FFS PV-Zero P/V vent valve shall be conducted with the valve remaining in its installed position on the vent line(s). The PV-Zero portion of this attachment for the Franklin Fueling Systems Phil-Tite/EBW/FFS) stage I EVR system outlines the equipment needed to test the valve in its installed position.

4. A manifold may be installed on the vent pipes to reduce the number of potential leak sources and P/V valves installed. Vent pipe manifolds shall be constructed of steel pipe or an equivalent material that has been listed for use with gasoline. If a material other than steel is used, the GDF operator must make available, upon request, information demonstrating that the material is compatible for use with gasoline. A tee may be located in a different position, or fewer pipes may be connected, or more than one P/V valve may be installed on the manifold.
5. Each P/V valve shall have permanently affixed to it a yellow, gold, or white colored label with black lettering stating the following specifications:

Positive pressure setting: 2.5 to 6.0 inches H₂O
Negative pressure setting: 6.0 to 10.0 inches H₂O
Positive Leak rate: 0.05 CFH at 2.0 inches H₂O
Negative Leak rate: 0.21 CFH at -4.0 inches H₂O

1. The vapor adaptor poppet shall not leak when closed. Compliance with this requirement shall be verified by the use of commercial liquid leak detection solution, or by bagging, when the vapor containment space of the underground storage tank is subjected to a non-zero gauge pressure. (Note: leak detection solution will detect leaks only when positive gauge pressure exists.)

Vapor Recovery and Product Adaptor Dust Caps

Dust caps with intact gaskets shall be installed on all stage I EVR tank adaptors.

Spill Container Drain Valve

The spill container drain valve is configured to drain liquid directly into the drop tube and is isolated from the underground storage tank ullage space. The leak rate of the drain valve shall not exceed 0.17 CFH at 2.00 inches H₂O. Depending on the presence of the drop tube overfill prevention device, compliance with this requirement shall be demonstrated in accordance with either TP-201.1C, Leak Rate of Drop Tube/Drain Valve Assembly (October 8, 2003), or TP-201.1D, Leak Rate of Drop Tube Overfill Prevention Device and Spill Container Drain Valve (October 8, 2003).

Drop Tube Overfill Prevention Device

1. The Drop Tube Overfill Prevention Device (overfill device) is designed to restrict the flow of gasoline delivered to the underground storage when liquid levels exceed a specified capacity. The drop tube overfill device is not a required component of the EVR system, but may be installed as an optional component of the system. Other requirements may apply.
2. The leak rate of the overfill device shall not exceed 0.17 CFH at 2.00 inches H₂O when tested as in accordance with TP-201.1D, Leak Rate of Drop Tube Overfill Prevention Device and Spill Container Drain Valves (October 8, 2003).
3. The discharge opening of the fill pipe must be entirely submerged when the liquid level is six inches above the bottom of the tank as shown in Figures 2A and 2D.

Riser Adaptor

For “Phil-Tite” series spill container installations, the Riser Adaptor shall provide a machined surface on which a gasket can seal and ensures that the seal is not compromised by an improperly cut or improperly finished riser. A Threaded Riser adaptor shall be installed on the following required connections. As an option, the adaptor may be installed on other connections.

- a. Product Spill Container (required)
- b. Vapor Recovery Spill Container (required)
- c. Tank Gauging Components (required)

For “Defender Series” spill container installations, the Riser Adaptor should only be used with the NPSM (straight thread) base. The Riser Adaptor should not be used with the Defender Series Base with NPT (tapered thread) base. This is applicable for both the vapor and fill/product sides. Field conditions will dictate which base to use. If the existing riser is not cut square, those conditions will require the riser adaptor.

Vapor Recovery Riser Offset

1. The EVR tank riser may be offset from the tank connection to the vapor recovery Spill Container provided that the maximum horizontal distance (offset distance) does not exceed twenty (20) inches. One example of an offset is shown in Figure 2E.
2. A vapor recovery riser shall be offset up to 20 inches horizontal distance with use of commercially available, four (4) inch steel pipe fittings, a Phil-Tite Model M-6050 Vapor Riser Offset, or a combination of the two products. An example of a Phil-Tite Model M-6050 configuration is shown in Figure 2E.

Tank Gauge Port Components

The tank gauge adaptor and cap are paired. Therefore, an adaptor manufactured by one company shall be used only with a cap manufactured by the same company.

Warranty

Each manufacturer listed in Exhibit 1 shall include a warranty tag with the certified component(s). The manufacturer warranty tag, included with each component, shall be provided to the service station owner/operator at the time of installation.

Connections and Fittings

All connections and fittings not specifically certified with an allowable leak rate shall not leak. The absence of vapor leaks shall be verified with the use of commercial liquid leak detection solution (LDS), or by bagging, when the vapor containment space of the underground storage tank is subjected to a non-zero gauge pressure. (Note: leak detection solution will detect leaks only when positive gauge pressure exists).

Double Fill Configuration

A Defender and or Phil-Tite Double Fill Configuration shall be allowed for installation provided that no more than two fill points are installed on any single underground storage tank and that no offset of the vapor recovery riser pipe is installed. An example of this configuration is shown in Figure 2C.

Maintenance Records

Each GDF operator or owner shall keep records of maintenance performed at the facility. Such record shall be maintained on site or otherwise readily available for review during the course of an on-site inspection. Additional information may be required in accordance with permit or OAR requirements. The records shall include the maintenance or test date, repair date to correct test failure, maintenance or test performed, affiliation, telephone number, and the name of the individual conducting maintenance or test. An example of a Stage I EVR Maintenance Record is shown in Figure 20.

**Table 2-1
Gasoline Dispensing Facility Compliance Standards and Specifications**

Component / System	Test Method	Standard or Specification
Rotatable Phase I Adaptors	TP-201.1B	Minimum, 360-degree rotation Maximum, 108 pound-inch average static torque
Overfill Prevention Device	TP-201.1D	≤0.17 CFH at 2.00 inches H ₂ O
Spill Container Drain Valve	TP-201.1C or TP-201.1D	≤0.17 CFH at 2.00 inches H ₂ O
P/V Valve ¹	TP-201.1E	Positive pressure setting: 2.5 to 6.0 inches H ₂ O Negative pressure setting: 6.0 to 10.0 inches H ₂ O Positive Leakrate: 0.05 CFH at 2.0 inches H ₂ O Negative Leakrate: 0.21 CFH at -4.0 inches H ₂ O
Vapor Recovery System	TP-201.3	As specified in TP-201.3 and/or CP-201
Connections and fittings certified without an allowable leak rate	Leak Detection Solution or bagging	No leaks

¹ Compliance determination is at the option of the district.

**Table 2-2
Maintenance Intervals for System Components²**

Manufacturer	Component	Maintenance Interval
All Models	Dust Caps	Annual
All Models	In Tank Gauge Port Probe Cap and Adaptor Kit	Annual
FFS	Drop Tube Overfill Prevention Device 70849X1Y series Drop Tube Overfill Prevention Device 70849X3Y series Drop Tube Overfill Prevention Device 70859X9YZ series Drop Tube Overfill Prevention Device 70869X9YZ series	Annual
FFS	782 Straight Drop Tube	Annual
Husky	Pressure/Vacuum Vent Valve	Annual
FFS	Pressure/Vacuum Vent Valve	Annual
OPW	Pressure/Vacuum Vent Valve	Annual
OPW	61-T Straight Drop Tube	Annual
FFS	Spill Container (all models)	Every 3 years
FFS	SWF-100-B Product Adaptor SWF-100-SS Product Adaptor	Annual
FFS	SWV-101-B Vapor Adaptor SWV-101-SS Vapor Adaptor	Annual

² Maintenance must be conducted within the interval specified from the date of installation and at least within the specified interval thereafter.

Figure 20

Example of a GDF Stage I Maintenance Record

Date of Maintenance/ Test/Inspection/ Failure	Repair Date to Correct Test Failure	Maintenance/Test/Inspection Performed and Outcome	Affiliation	Name of Individual Conducting Maintenance or Test(s)	Telephone Number



State of Oregon
**Department of
Environmental
Quality**

Installation, Operation and Maintenance Manual

For Executive Order

VR-101-V
Franklin Fueling Systems, Inc.
Phil-Tite/EBW/FFS Stage I Enhanced
Vapor Recovery System

NOTICE:

This Installation, Operation and Maintenance Manual for the Franklin Fueling System stage I EVR System describes the tools and methods required to install the FFS stage I EVR System. While Oregon DEQ does not require specific certification or training to install, maintain, or repair stage I EVR systems, owners or operators may elect to contract with certified technicians.

Note: CARB requires that only technicians trained and certified by FFS (i.e. FFS Certified Technicians) are able to perform installation, maintenance or repairs of components manufactured by FFS or the warranty will be void. A list of FFS Certified Technicians can be viewed at <http://www.franklinfueling.com/service/>.

To schedule a training class, FFS can be contacted at the following:

Enhanced Vapor Recovery Systems
Franklin Fueling Systems
Phone: 800-225-9787
Email: techserve@franklinfueling.com

It is the responsibility of each service provider or technician to be familiar with the current requirements of state, federal and local codes for installation and repair of gasoline dispensing equipment. It is also the responsibility of the service provider or technician to be aware of all necessary safety precautions and site safety requirements to assure a safe and trouble free installation.

In addition to the requirements included in this attachment, the owner or operator of a GDF may wish to obtain a warranty tag for each stage I EVR component installed. Warranty tags are described in more detail in the CARB Executive Orders and may be included with each component, to the service station owner/operator at the time of installation.

<p>Spill Container Drain Valve (continued)</p> <p>Phil-Tite “All Models with Drain Valves”</p>	<p>Every year inspection; every 24 months for testing</p>	<ol style="list-style-type: none"> 3. Inspect the drain valve-screen assembly and ensure there are no cracks or cuts. Inspect the shut-off collar for nicks, cuts, wrapped, etc. If the above are damage, replace the drain valve assembly (85400). 4. Remove any liquid and debris (sand, grit, dirt, dust, etc.) that may be under the drain valve assembly. Check the drain valve “O”-Ring (85035) for any wear, cuts, tears and debris. Clean and/or replace if necessary. 5. Reinstall the drain valve and handle assembly (85400) using the Installation and Adjustment instructions found within IOM. Check the drain valve handle for proper operation. NOTE: The drain valve handle must snap into place when moved to the closed position! Re-adjust if necessary. 6. Remove the black spill container using an approved installation/extraction tool (T-7101 or T-7002, Black) from Phil-Tite T-7043 Tool Kit. 7. Inspect the ¼” flat seal (85039) (black spill container to M/F 4X4 riser adaptor seal) for cuts or damage, replace if necessary. 8. If there is no M/F 4X4 riser adaptor installed on top of the tank riser this could be the reason for failing TP-201.1C performance test. Install a Phil-Tite M/F 4X4 Riser Adaptor. Note: Install only one (1) M/F 4X4 Riser adaptor per tank riser. Two or more on top of a single tank riser will cause test failures. 9. Inspect the drop tube round seal for correct installation, cuts or damage, replace if necessary (85039-DT). Note: The drop tube seal must be Phil-Tite’s special round seal (85039-DT), Do Not use a standard ‘O’-Ring. 10. Reinstall the black spill container using the installation instructions provided, and perform ARB test procedure TP-201.1C – Leak Rate of Drop Tube/ Drain Valve Assembly.
<p>(Spill Container Drain Valve continued next page)</p> <p>(Spill Container Drain Valve continued)</p>	<p>Every year inspection; every 24 months for testing</p>	<ol style="list-style-type: none"> 1. Perform ARB test procedure TP-201.1C – Leak Rate of Drop Tube/Drain Valve assembly.

Summary of Maintenance Activities Required of the FFS Stage I EVR System ¹		
Component	Interval	Maintenance To Be Performed
Defender Series with EBW 70533729 EBW Series with 70533719 Drain Valve; or 70533729 Drain Valve	Every year inspection; every 24 months for testing	<ol style="list-style-type: none"> 2. Clean any sand, gravel, or dirt from the snow plow ring. Buildup of material will prevent the manhole lid from sitting flat and diverting rain water. In addition to water infiltration, this can lead to premature lid failures and tripping hazards. 3. Inspect the cover gasket and replace if necessary. 4. Inspect the spill container for the presence of liquid. If any is present, identify the material (water or fuel) and dispose of it using your preferred acceptable method (pump it out or drain it into the tank). 5. Inspect the primary spill container and drain valve screen for any foreign material collecting in the area. Remove any large objects, (leaves, rags, etc.) and wipe the bottom of the tank with a disposable rag. <p><i>Note: For Defender EVR installations, the Defender Spill Container is installed first on the UST Fill Riser. The Drop Tube is installed through the installed spill container before installing the Drop Tube Riser Clamp inside the spill container.</i></p> <ol style="list-style-type: none"> 6. Inspect the entire spill container assembly and any components for obvious damage. Verify that all components are functioning properly. 7. Record inspection results.

1

¹ These maintenance requirements shall not circumvent use of the manufacturer's installation and maintenance instructions. Maintenance contractors or owner/operators shall refer to the manufacturers complete installation and maintenance instructions to ensure that all maintenance and torque requirements are met. Maintenance must be conducted within the interval specified from the date of installation and at least within the specified interval thereafter.

Summary of Maintenance Activities Required of the FFS Stage I EVR System ¹ (continued)		
Component	Interval	Maintenance To Be Performed
Pressure/Vacuum Vent Valve FFS Model 407215901 PV-Zero (Gas/E85)	Annual	<ol style="list-style-type: none"> 1. Visual inspect housing, pipe, fittings and rain cap for obvious signs of damage, missing parts or fluid leaks. 2. Visually inspect the rain cap, from ground level, for signs of bird nests or insect activity. 3. Every year, drain and inspect the fill fluid per the Fluid Inspection Procedure.
Pressure/Vacuum Vent Valve Husky Model 5885	Annual	<ol style="list-style-type: none"> 1. Remove screws that hold top cover on. 2. Remove any debris that might be sitting inside the lower cover. 3. Check the drain holes in the lower cover for blockage. 4. Do not remove the two (2) screens. 5. Reinstall the top cover and retaining screws. 6. Tighten the screws firmly.
Pressure/Vacuum Vent Valve OPW Model 723V	Annual	<p>Upper Screen Maintenance</p> <ol style="list-style-type: none"> 1. Remove vent top by depressing tabs and lift top upwards. 2. Clean and replace filter screen as necessary. 3. Reinstall vent top by inserting into the body. <p>Lower Screen Maintenance</p> <ol style="list-style-type: none"> 1. Remove valve assembly from pipe adaptor. Grip assembly at the flats just above the pipe adaptor and unscrew. 2. Lift the filter screen out and clean or replace as necessary. 3. Reinstall filter screen in the pipe adaptor. 4. Reinstall valve assembly on pipe adaptor and tighten.
Dust Caps	Annual	Visually inspect the seal in cap and replace if damaged or missing.
Drop Tubes OPW 61T EBW 782-204-1 EBW 782-204-3	Every year inspection; every 24 months for testing	<ul style="list-style-type: none"> • Visually inspect Drop Tube to see if it is installed and ensure that the bottom of tube is within 6 inches of the bottom of tank. • Test the drop tube seal with procedure TP-201.1C. If the drop tube seal passes testing, no further maintenance is required. If the drop tube seal fails testing, replace the drop tube seal with Phil-Tite 85039-DT "O"-ring. • Re-test the drop tube seal with procedure TP-201.1C.
Overfill Prevention Devices	Annual	<ul style="list-style-type: none"> • Annually, inspect the valve for any noticeable damage by looking down the drop tube opening. If any damage is observed, the valve must be replaced. • Test the seals with procedure TP-201.1D. If the drop tube passes testing, no further maintenance is required. If the drop tube fails testing, replace the drop tube seal with Phil-Tite 85039-DT. • Re-test the valve with procedure TP-201.1D. If this does not correct the leak the valve needs to be replaced.

¹ These maintenance requirements shall not circumvent use of the manufacturer's installation and maintenance instructions. Maintenance contractors or owner/operators shall refer to the manufacturers complete installation and maintenance instructions to ensure that all maintenance and torque requirements are met. Maintenance must be conducted within the interval specified from the date of installation and at least within the specified interval thereafter.

Summary of Maintenance Activities Required of the FFS Stage I EVR System ¹ (continued)		
Component	Interval	Maintenance To Be Performed
Vapor Recovery Adaptor Phil-Tite SWV-101-B and SWV-101-SS	Every year inspection; every 24 months for testing	<p><i>The Phil-Tite rotatable adaptors are not field serviceable, with the exception of the vapor swivel poppet 'O'-Ring found on the Vapor swivel adaptor (SWV-101-B and SWV-101-SS).</i></p> <p>The swivel tops should rotate 360 degrees by hand. If you can rotate the swivel tops by hand you are applying less than 108 in. lbs. of static torque.</p> <p>If a leak is found in the vapor top poppet, inspect the brass/stainless steel vapor top for 'out of round' condition. Check the poppet 'O'-Ring seal for sand, dirt, dust, grit and abrasions between the poppet 'O'-Ring and the brass/stainless steel sealing surface. (These conditions are not covered by the warranty.)</p> <p>To check and/or replace the vapor swivel poppet 'O'-Ring:</p> <ol style="list-style-type: none"> 1. Remove the vapor swivel adaptor (SWV-101-B or SWV-101-SS) from the black spill container riser using the special tool adaptor (T-7102, orange) from the Phil-Tite Tool Kit (T-7043). 2. Using a small blade common screwdriver remove the ¼ inch flat seal gasket from the bottom of the vapor adaptor. 3. Push down on the brass/stainless steel spider a ½ inch or so, using a small blade common screwdriver, remove the retainer ring. (Warning: The spider and spring assembly are spring loaded.) This will release the spider assembly, spring, and poppet assembly. By hand, carefully remove these parts. 4. With the vapor poppet assembly removed, inspect the poppet and poppet 'O'-Ring for cuts, tears or damage. Replace the 'O'-Ring if necessary. Before re-assembly spray a small amount of Silicone Spray on the poppet 'O'-Ring. NOTE: DO NOT USE ANY TYPE OF OIL OR GREASE. 5. Re-assemble the vapor poppet, spring and brass/stainless steel spider in the reverse order from which they were removed.

(Vapor Recovery Adaptor)
continued next page)

¹ These maintenance requirements shall not circumvent use of the manufacturer's installation and maintenance instructions. Maintenance contractors or owner/operators shall refer to the manufacturers complete installation and maintenance instructions to ensure that all maintenance and torque requirements are met. Maintenance must be conducted within the interval specified from the date of installation and at least within the specified interval thereafter.

Summary of Maintenance Activities Required of the FFS Stage I EVR System ¹ (continued)		
Component	Interval	Maintenance To Be Performed
Vapor Recovery Adaptor Phil-Tite SWV-101-B and SWV-101-SS (continued)		<p>6. Install the retainer ring and actuate the poppet by hand, making sure the assembly is secure and actuates properly.</p> <p>7. Using a very small screwdriver, Install a new ¼ inch flat seal (85039). Make sure the ¼ inch flat seal is seated against the sealing surface below the swivel adaptor threads.</p> <p>8. Reinstall the SWV-101-B or SWV-101-SS vapor swivel on the black spill container riser as described in the “Installation Instructions” and properly torque the swivel adaptor on the spill container riser between 50 and 75 ft. lbs.</p> <p>Important: Apply an even coating of silicone based spray or a light coating of anti-seize compound to the male threads of the spill container riser and/or the swivel adaptor female threads. This will reduce the friction between these threads during installation and aid in removal of the swivel adaptor at a later date.</p>
Tank Gauge Components Morrison Brothers 305 series Veeder-Root 312020-952 EBW 90037 E	Annual	<p>Visually inspect cap to see that it is not missing any seals and is properly installed.</p> <p>Whenever probe service is necessary, also inspect the service cap seal for damage and replace, if necessary, at that time.</p>

¹ These maintenance requirements shall not circumvent use of the manufacturer’s installation and maintenance instructions. Maintenance contractors or owner/operators shall refer to the manufacturers complete installation and maintenance instructions to ensure that all maintenance and torque requirements are met. Maintenance must be conducted within the interval specified from the date of installation and at least within the specified interval thereafter.

Summary of Maintenance Activities Required of the FFS Stage I EVR System ¹ (continued)		
Component	Interval	Maintenance To Be Performed
Spill Container Lid Phil-Tite 85011	Every year inspection; every 24 months for testing	<p>NOTE: DO NOT USE ANY PETROLEUM PRODUCTS ON THE WIPER SEAL, CAST IRON LID, OR THE STAINLESS STEEL SLEEVE.</p> <ul style="list-style-type: none"> • Clean the wiper seal using a clean rag and silicone spray. The Wiper Seal must be free of any dirt, dust and/or film build up. If unable to properly clean, replace the wiper seal (SC-1513V). <p>Check the Wiper Seal for Flexibility:</p> <ol style="list-style-type: none"> 1. Place your thumbs on the outer surface of the seal approximately 4-6 inches apart. Push your thumbs toward each other. The wiper seal should have some movement between your thumbs. If there is no movement or flexibility, the wiper seal must be replaced and/or removed, cleaned, and rechecked. 2. Remove the wiper seal and clean the groove in the cast iron lid of any dirt or dust build up by using a clean rag and silicone spray. The use of a blunt tool may be required to remove any build up. 3. Clean all surfaces of the wiper seal using a clean rag and silicone spray. Any dirt or dust build up in the "U" section of the seal must be removed. The use of a wooden or plastic tipped instrument along with silicone spray may be required. If unable to properly clean, replace the wiper seal (SC-1513V). <p>Installing the Wiper Seal (SC-1513V) into the Groove of the Cast Iron Lid</p> <ol style="list-style-type: none"> 1. Install the wiper seal in the cast iron lid groove with the small (wiper) bulge facing outward and pointing upwards. Check the circumference of the installed seal for any twists or incorrect alignment of the seal in the groove.
(Spill Container Lid continued next page)		

¹ These maintenance requirements shall not circumvent use of the manufacturer's installation and maintenance instructions. Maintenance contractors or owner/operators shall refer to the manufacturers complete installation and maintenance instructions to ensure that all maintenance and torque requirements are met. Maintenance must be conducted within the interval specified from the date of installation and at least within the specified interval thereafter..

Summary of Maintenance Activities Required of the FFS Stage I EVR System ¹ (continued)		
Component	Interval	Maintenance To Be Performed
Spill Container Lid Phil-Tite 85011	Every year inspection; every 24 months for testing	<p>Check the Stainless Steel Sleeve for Cleanliness</p> <ol style="list-style-type: none"> 1. Clean the area of the stainless steel sleeve where the wiper seal makes contact with the sleeve. Using a clean rag and silicone spray, wipe this area free of any dirt, dust and/or film build up. <p>Reinsert the Lid with Wiper Seal over the Spill Container and into the Stainless Steel Sleeve.</p> <p><i>Note: To ease installation use <u>silicone spray on the exposed surface of the wiper seal and on the lip of the stainless steel sleeve where the wiper seal makes contact. Do not use any petroleum products.</u></i></p> <ul style="list-style-type: none"> • Push down on the cast iron lid until it seats into the stainless steel sleeve. • Hold the cast iron lid until it seats into the stainless steel sleeve. • If the cast iron lid does not stay seated, wait five (5) seconds then push down on the cast iron lid again. You will feel the cast iron lid go down and seat into the stainless steel sleeve. • Repeat this process until the cast iron lid stays seated in the stainless steel sleeve.
EBW/Defender Lids 7054401X		<ul style="list-style-type: none"> • Wipe lid seal and spill container sealing surface with a rag to remove any dirt/debris. • Inspect the lid seal for any damage and replace if necessary. • Inspect the spill container sealing surface for any damage and replace if necessary. • • • (End of maintenance table.)

These maintenance requirements shall not circumvent use of the manufacturer’s installation and maintenance instructions. Maintenance contractors or owner/operators shall refer to the manufacturers complete installation and maintenance instructions to ensure that all maintenance and torque requirements are met. Maintenance must be conducted within the interval specified from the date of installation and at least within the specified interval thereafter

**Franklin Fueling Systems
Stage I EVR Equipment Installation Check List
Installing Components per Executive Order VR-101**

Date: _____

Site Location:(*name*) _____ Installing Contractor:(*name*

_____ Address _____ Address

City/State

_____ City/State _____

Contact/Phone _____ Contact/Phone

Tank Number: _____ Product: _____ Capacity: _____

Yes/No	Initials

Tank Number: _____ Product: _____

Capacity: _____

Tank Number: _____ Product: _____

Capacity: _____

Installing Technician: (*name*): _____

Technician Certification Number: _____ Signature: _____

1. Is all of the installed equipment for Stage I EVR listed in Executive Order (E.O.) VR-101-O?

Note: All Stage I installed equipment must be listed in an E.O. within this attachment. If other approved equipment is installed, explain which components were substituted in this checklist. Mark/check off each item installed.

Yes/No	Initials

2. Have all tank risers been cut to the correct lengths and correctly installed into the tank bungs using an approved pipe dope?

Yes/No	Initials
Yes/No	Initials

3. For sites equipped with Phil-Tite series spill containers, and Defender Series spill containers with straight (NPSM) threads, do all tank risers that have a gasket/seal cap and/or spill containers have an M/F 4X4 Riser Adaptor installed?

a. Are all M/F 4X4 Riser Adaptors installed onto tank risers using approved pipe dope and torque to _____ ft. lbs.?

Yes/No	Initials

4. If a mechanical overfill prevention drop tube is installed, has the sealant (epoxy) been allowed to cure a minimum of 4 hours before installation? (EBW 70849X-1Y & 70849X-3Yonly)

5. For sites equipped with Phil-Tite series spill containers, on the fill riser – Is the Drop Tube installed (under the spill container) using Phil-Tite Special 'O' Ring (85039-DT) with the flared end on top of the M/F 4X4 Riser Adaptor?
6. For sites equipped with Defender spill containers, on the fill riser, is the Drop Tube installed inside the spill container and under the Drop Tube Riser Clamp.

Note: EBW 70849X1Y and EBW 70849X-3Y drop tubes with mechanical overfill prevention valves must be cut to the correct length and the upper end flared using Flaring Tool T-6100-FT before installing into the tank riser.

**Franklin Fueling Systems
 Stage I EVR Equipment Installation Check List (con't.)
 Installing Products per ARB Executive Order VR-101-O**

Yes/No	Initials	7. For sites equipped with Phil-Tite series spill containers, are they installed onto the M/F 4X4 riser adaptors using approved anti- seize compound or silicone spray and torque to _____ ft. lbs.?
--------	----------	--

Yes/No	Initials	8. Are the Fill and Vapor Swivel Adaptors installed onto the spill container risers using an approved anti-seizing compound or spray silicone and torque to _____ ft. lbs.?
--------	----------	---

Yes/No	Initials	8. Pressure Vacuum Vent Valve – Is there a P/V Vent valve installed on the top of each (Gas or Gas/E85) vent pipe (a maximum of three EVR P/V valves per GDF) or manifold?
--------	----------	--

Yes/No	Initials	a. P/V vent valve(s) torque to _____ ft. lbs.
--------	----------	---

Yes/No	Initials	9. Tank Gauge Port Cap and Adaptor – If installed,
Yes/No	Initials	a. Has an M/F 4X4 Riser Adaptor been installed onto the tank gauge riser using an approved pipe dope and torque to _____ ft. lbs.

Yes/No	Initials	b. Is the Tank Gauge Adaptor installed onto the M/F/ 4X4 riser adaptor using an approved anti-seize compound and torque to _____ ft. lbs.?
--------	----------	--

FFS Stage I Vapor Recovery System Exhibit 1 Equipment Checklist

On line below, write out what configuration you used. Follow the legend below for each series spill container.

Configuration used: _____

(Gas/E85) = Identifies equipment approved for use with standard gasoline fuel blends and E85

(Gas) = Identifies equipment approved for use only with standard gasoline fuel blends

Equipment
Spill Container
(Phil-Tite Series)

Manufacturer/Model Number

- Phil-Tite 85100-1 and 85100 Series (Gas/E85)
(Replacement only for existing installations)

8510X-1 and 8510X legend:

X represented by:

- 0 = product spill container
- 0-EXT = product spill container w extension collar
- 1 = vapor spill container
- 1-EXT = vapor spill container w extension collar

Spill Container
(Defender Series)

- EBW Defender 705 Series* (Gas/E85)

Defender 705 Series Legend* (Gas/E85)

7055XYZAB where XYZAB is represented by:

X = containment

- 4 = single wall
- 5 = double wall

Y = installation

- 2 = multiport bucket
- 5 = direct bury

Z = interstitial monitoring method

- 0 = no sensor/gauge (i.e. single wall)
- 1 = I2 monitor (float gauge, visual)
- 2 = TSP-ULS (electronic sensor)

A = spill container base thread**

- 0 = NPSM (straight thread)
- 1 = NPT (taper thread)

B = drain valve

- 1 = with drain valve (typical on product/fill side)
- 2 = without drain valve (typical on vapor side)

EBW Series

- EBW 7XX49Y0Z
EBW Series Legend

XX indicates spill bucket size:

- 05 = 5 gallon
- 15 = 15 gallon

Equipment**Manufacturer/Model Number**

Y indicates level:

- 0 = grade level with cast iron base (5 gal only)
- 2 = below grade level with cast iron base (5 & 15 gal)

Z indicates drain valve:

- 1 = drain valve
- 2 = no drain valve

*May be installed in direct bury or multi-port configurations including single fill or double tank riser orientations.

**NPSM base thread spill containers (straight thread) are designed for use with the Phil-Tite M/F 4X4 Riser Adaptor at sites where the NPT threads of the tank riser are not cut flat or square. NPT base spill containers (taper thread) do not require use of Phil Tite M/F Riser Adaptor at sites where the NPT threads of the tank riser are flat and cut square.

**Spill Container Lid
(Phil-Tite Series Spill
Containers)**

- Phil-Tite 85011 (Gas/E85)

**Spill Container Lid
(Defender and EBW
Series)**

- EBW 7054401X (Gas/E85)

X = Lid Color

**Replacement
Drain Valve
(Phil-Tite Series
Spill Containers)**

- Phil-Tite 85400 (Gas/E85)

**Replacement
Drain Valve
(Defender Series Spill
Containers)**

- EBW 70533729 (Gas/E85)

**Replacement
Drain Valve (EBW
Series Spill Container)**

- EBW 70533719 (Gas)

**Drain Valve Blank Kit
EBW Series Spill
Container**

- EBW 90022

**Drain Valve Blank Kit
(Defender Series Spill
Container)**

- EBW 9002201

**Drain Valve Isolation
Kit (EBW Series Spill
Containers)**

- EBW 70825501

**Drain Valve Isolation
Test Kit (EBW Series
Spill Containers)**

- EBW 90079

<u>Equipment</u>	<u>Manufacturer/Model Number</u>
Product Adaptor	<input type="checkbox"/> Phil-Tite SWF-100-B (Gas)
	<input type="checkbox"/> Phil-Tite SWF-100-SS (Gas/E85)
Vapor Adaptor	<input type="checkbox"/> Phil-Tite SWV-101-B (Gas)
	<input type="checkbox"/> Phil-Tite SWV-101-SS (Gas/E85)
Riser Adaptor	<input type="checkbox"/> Phil-Tite M/F 4X4* (Gas/E85)
	<input type="checkbox"/> Phil-Tite M/F 4X4-R* (Gas/E85)
Riser Support Bracket	<input type="checkbox"/> Phil Tite M 1600 (Gas/E85)
Drop Tube Riser Clamp (Defender Series Spill Containers)	<input type="checkbox"/> FFS 70550901EC (Gas/E85)
Dust Cap	<input type="checkbox"/> Morrison Brothers 323C-0100ACEVR (vapor) (Gas/E85)
	<input type="checkbox"/> Morrison Brothers 305C-0100ACEVR (product)(Gas/E85)
	<input type="checkbox"/> OPW 1711T-EVR (vapor) (Gas/E85)
	<input type="checkbox"/> OPW 634TT-EVR (product) (Gas/E85)
	<input type="checkbox"/> OPW 634LPC (product) (Gas)
	<input type="checkbox"/> OPW 1711LPC (vapor) (Gas)
	<input type="checkbox"/> CompXCSP1-634LPC (product) (Gas)
	<input type="checkbox"/> CompXCSP3-1711LPC (vapor) (Gas)
	<input type="checkbox"/> CompXCSP2-634LPC (product) (Gas)
	<input type="checkbox"/> CompXCSP4-1711LPC (vapor) (Gas)
	<input type="checkbox"/> EBW 77720102 (product) (Gas/E85)
	<input type="checkbox"/> EBW 77720202 (product) (Gas/E85)
	<input type="checkbox"/> EBW 30420006 (vapor) (Gas/E85)
	<input type="checkbox"/> EBW 30430103 (vapor) (Gas/E85)
Pressure/Vacuum Vent Valve	<input type="checkbox"/> FFS PV-Zero 407215901 (Gas/E85)
	<input type="checkbox"/> Husky 5885 (Gas/E85)
	<input type="checkbox"/> OPW 723V (Gas/E85)
Tank Gauge Port Components	<input type="checkbox"/> Veeder-Root 312020-952 (cap and adaptor kit) (Gas/E85)
	<input type="checkbox"/> Morrison Brothers 305XPA1100AKEVR (cap and adaptor kit) (Gas/E85)
	<input type="checkbox"/> Morrison Brothers 305-0200AAEVR (replacement adaptor) (Gas/E85)
	<input type="checkbox"/> Morrison Brothers 305XP-110ACEVR (replacement cap) (Gas/E85)
	<input type="checkbox"/> EBW 90037-E (In Tank Probe Cap and Adapter Kit) (Gas/E85)
Drop Tube Overfill Prevention Device¹	<input type="checkbox"/> Defender Series OPV 70859X9YZ, 70869X9YZ (Gas/E85) Defender Series OPV legend

X = upper drop tube length:

1 = 5 feet

2 = 10 feet

Y = Tube compatibility:

Equipment**Manufacturer/Model Number**

- 0 = Gas
- 2 = Gas/E85

Z = lower drop tube length:

- 1 = 8 feet
- 2 = 10 feet

- EBW 70849X1Y (Gas)
- EBW 70849X3Y (Gas/E85)

X represented by:

- 1 = 5 foot length upper drop tube section
- 2 = 10 foot length upper drop tube section

Y represented by:

- 1 = 8 foot length bottom thread on section drop tube
- 2 = 10 foot length bottom thread on section drop tube

Drop Tube¹

- OPW 61-T (various lengths) (Gas)
- EBW 7822041X-2 (X = various lengths) (Gas)
- EBW 7822043X-2 (X = various lengths) (Gas/E85)

Riser Offset¹

- Phil-Tite M-6050-X (x = various offsets) (Gas/E85)

**Double Fill¹
Tank Riser
Configuration**

- Phil Tite (configuration only) (Gas/E85)
- Defender (configuration only) (Gas/E85)

**Tank Bottom
Protector¹**

- Phil-TiteTBP-3516-E (Gas/E85)

Fuel Lock¹

- McGard FL1 – Stick Only Fuel Lock (125007) (Gas)
- McGard FL2 – Stick/Sampling Fuel Lock (125008) (Gas)

Bladder Plug

- McGard PSI104 (Gas)

¹ If these components are installed, only those, components and model numbers specified above shall be installed or used.

NOTE:

(Gas/E85) = Identifies that these components are approved for standard gasoline and E85 fuel blends.

(Gas) = Identifies that these components are only approved for standard gasoline fuel blends.

Table 1
Components Exempt from Identification Requirements

Component Name	Manufacturer	Model Number
Drop Tube	OPW EBW EBW	61-T Straight Drop Tube (Gas) 7822041X-2 (X = various lengths) (Gas) 7822043X-2 (X = various lengths) (Gas)
Dust Caps	Morrison Brothers	323C-0100ACEVR (vapor)* (Gas/E85) 305C-0100ACEVR (product)* (Gas/E85)
Tank Gauge Port Components	Veeder-Root	312020-952 (cap & adaptor) (Gas/E85)
	Morrison Brothers	305XPA1100AKEVR (cap and adaptor kit) (Gas/E85) 305-0200AAEVR (replacement adaptor) (Gas/E85) 305XP-1100ACEVR (replacement cap) (Gas/E85)
	EBW	90037-E (In Tank Probe Cap and Adaptor Kit) (Gas/E85)
Riser Adaptor	Phil-Tite	M/F 4X4 (Gas/E85) M/F 4X4-R (Gas/E85)
Riser Offset	Phil-Tite	M-6050-X (X = various offsets) (Gas/E85)
Riser Support Bracket	Phil-Tite	M-1600 (Gas/E85)
Spill Container Lid	Phil-Tite EBW	85011 (Gas/E85) 7054401X (Gas/E85)
Sump/Sump Lids	Varies	Varies (Gas/E85)
Drop Tube Riser Clamp	FFS	70550901EC (Gas/E85)
Replacement Drain Valve	EBW	EBW 70533729 EBW 70533719
Fuel Lock	McGard	FL1, FL2

* Morrison Brothers dust caps identified as 323C EVR and 305C EVR respectively.

Overfill Prevention Valve Installation Record Sheet

Date Installed _____

Valve Serial Number

5 0 _____ 0

Site information

Site # / Description _____

Site Address _____

Site Contact _____

Installing Contractor

Name _____

Company _____

Tank Information

Product Type _____

Underground Tank Manufacturer _____

Tank Full Volume _____

Tank Diameter _____

Tank Chart Available? Yes No

Tank Type Steel Fiberglass

Square Cylinder Dome Ends

Tank have compartments? Yes No

Tank/Drop Tube Measurements

Upper Drop Tube Length (X) _____

Lower Drop Tube Length (Y) _____

Distance from Lower Drop tube to tank bottom _____

Dimensions

A _____

B _____

Operational Inspection Procedure Performed

Yes

No

Initials

Date

Franklin Fueling Systems • 3760 Marsh Rd. • Madison, WI 53718 USA

Tel: +1 608 838 8786 • 800 225 9787 • Fax: +1 608 838 6433 • www.franklinfueling.com



State of Oregon
**Department of
Environmental
Quality**

Equipment and Components

Executive Order

VR-102-V
OPW
Stage I Enhanced Vapor
Recovery System

Exhibit 1

OPW Stage I EVR System Equipment List

Equipment

Manufacturer/Model Number

(GAS/E85) = Identifies that these components are approved for standard gasoline & E85 fuel blends

Spill Containers¹

Direct Bury Spill Container OPW 1-Series (GAS/E85)
(Figure 1-1)

1-2100 Series

1WW-21XXY-ZEVR -G

1-2200 Series

1WW-22XQZ-G

1-3100 Series

1WW-3VVUTZ-G

1-Series legend

WW A or Blank (Aluminum Cover)

C (cast Iron or Ductile)

SC (Sealable Cover, Cast Aluminum)

PC (Plow Ring Rain Tight Cast Iron Ductile, 1-2000
only)

PSC (Plow Ring Sealable Cover, Cast Aluminum, 1-
2200 only)

XX 00 (5 Gal)

X 0 (5 Gal)

Y C (Cast Iron Base)

Blank (composite base)

Z D (drain valve)

P (plug)

VV 1 (5 gallon)

15 (15 gallon)

7 (5 gallon, steel cover)

U 0 (no gauge)

1 (float gauge)

2 (sensor)

3 (float and sensor)

4 (alternate sensor)

T 1 (single wall, cast iron 2100 style base)

2 (double wall)

3 (single wall, cast iron 3100 style base)

Q 0 (flange adaptor, cast iron base)

4 (no flange, 4" thread cast iron base)

G Color (varies)

¹ Drain valves are an optional component for OPW 1-Series product spill containers. If a drain valve is not installed in the OPW 1-Series product spill container, then either an OPW factory installed drain plug or OPW field drain plug kit 1DP-2100 must be installed.

Exhibit 1 (continued)

OPW Stage I EVR System Equipment List

<u>Equipment</u>	<u>Manufacturer/Model Number</u>
Spill Containers	Multiport Spill Container OPW 1-Series (GAS/E85) (Figure 1-2) 1-2100SH Series 1-2100Y-ZSH P700 Series P7MM-HHKK P500 Series P5MM-ZHHBJJJ P5MM-NN-HHKK 1-Series legend MM 11 (Composite Base) 11C (Cast Iron Base) 61 (Cast Iron Base) 61C (Cast Iron Base) NN Blank (5 gallon) 15 (15 gallon) HH EVR (Enhanced Vapor Recovery) FL (Fibrelite) KK DV (drain valve) PL (plug) Y C (Cast Iron Base) Blank (composite base) Z D (drain valve) P (plug) JJJ -14 (14" center spacing) BUCKET (16" or larger center spacing)
Replacement Drain Valve Kit	OPW 1DK-2100 (GAS/E85)
Replacement Drain Plug Kit	OPW 1DP-2100 (can be used with any OPW 1-Series Spill Containers) (Figure 1-3 and Figure 1-4)
Dust Caps	OPW 634LPC (product) (GAS/E85) (Figure 1-5) OPW 1711LPC (vapor) (GAS/E85) (Figure 1-6)

Exhibit 1 (continued)

OPW Stage I EVR System Equipment List

<u>Equipment</u>	<u>Manufacturer/Model Number</u>
Dust Caps (continued)	OPW 634TT-EVR (product) (GAS/E85) (Figure 1-7)
	OPW 1711T-EVR (vapor) (GAS/E85) (Figure 1-8)
	CompX CSP1-634LPC (Figure 1-9)
	CompX CSP3-1711LPC (vapor) (Figure 1-10)
	CompX CSP2-634LPC (product) (Figure 1-11)
	CompX CSP4-1711LPC (vapor) (Figure 1-12)
Product Adaptor	OPW 61SALP (Figure 1-13)
	OPW 61SALP-MA (GAS/E85) (Figure 1-15)
Vapor Adaptor	OPW 61VSA (Figure 1-14)
	OPW 61VSA-MA (GAS/E85) (Figure 1-16)
Pressure/Vacuum Vent Valve	FFS PV-Zero (Gas/E85) (Figure 1-17)
	OPW 723V (Gas/E85) (Figure 1-18)
	Husky 5885 (Gas/E85) (Figure 1-19)
Jack Screw Kit	OPW 61JSK-4410 (Only used with Composite Base Spill Container) (Figure 1-20)
	OPW 61JSK-44CB (Only used with Cast Iron Base Spill Container) (Figure 1-20)
	OPW 61JSK-4RMT (Only Used on Remote-Fill Configuration) (Figure 1-20)
	OPW 71JSK-44MA (GAS/E85) (Figure 1-21)
	OPW 71JSK-4RMT (GAS/E85) (Figure 1-21)
Face Seal Adaptor	OPW FSA-400
	OPW FSA-400-S (GAS/E85) (Figure 1-22)
Drop Tube	OPW 61T (various lengths)
	OPW 61T-SS (various lengths) (GAS/E85)

Exhibit 1 (continued)

OPW Stage I EVR System Equipment List

<u>Equipment</u>	<u>Manufacturer/Model Number</u>
Drop Tube Overfill Prevention Device ²	OPW 61SO (Figure 1-23) OPW 61SOM-412C-EVR (GAS/E85) OPW 71SO (Figure 1-24) OPW 71SO Testable (Figure 1-25) OPW 71SOM-412C (GAS/E85) (Figure 1-26) FFS Defender OPV series 70859X9YZ (Gas/E85 compatible) FFS Defender OPV series 70869X9YZ (Gas/E85 compatible) (Figure 1-27) Defender Series OPV legend: X = upper drop tube length: 1 = 5 feet 2 = 10 feet Y = Tube compatibility: 0 = Gas 2 = Gas/E85 Z = lower drop tube length: 1 = 8 feet 2 = 10 feet
Multiport	OPW (Configuration Only)
Remote Fill	OPW (Configuration Only)
Remote Additive Fill	OPW (Configuration Only)
Tank Bottom Protector²	OPW/Pomeco 6111-1400
Tank Gauge Port Components²	OPW 62M (Cap and Adaptor) (Figure 1-28) OPW 62M-MA (GAS/E85) (Figure 1-29) Morrison Brothers 305XPA1100AKEVR (GAS/E85) (cap & adaptor kit) Morrison Brothers 305-0200AAEVR (GAS/E85) (replacement adaptor) Morrison Brothers 305XP-110ACEVR (GAS/E85) (replacement cap)

² If these components are installed or required by regulations of other agencies, only those components and model numbers specified above shall be installed or used.

Fuel Lock²	Veeder-Root 312020-952 (cap & adaptor) McGard FL1 – Stick Only Fuel Lock (125007) (GAS) (Figure 1-30) McGard FL2 – Stick/Sampling Fuel Lock (125008) (GAS) (Figure 1-30)
Bladder Plug	McGard PSI104
Emergency Vent	Exhibit 5 (for below-grade vaulted tank configuration)

Exhibit 1 (continued)

**Table 1-1
Components Exempt from Identification Requirements**

Component Name	Manufacturer	Model Number
Product Adaptor	OPW	61SALP-MA (GAS/E85)
Vapor Adaptor	OPW	61VSA-MA (GAS/E85)
Replacement Drain Valve	OPW	1DK-2100
Replacement Drain Plug Kit	OPW	1DP-2100
Jack Screw Kit	OPW	61JSK-4410* 61JSK-44CB* 61JSK-4RMT* OPW 71JSK-44MA (GAS/E85) OPW 71JSK-4RMT (GAS/E85)
Tank Gauge Port Component (Cap and Adaptor)	Morrison Brothers	305XPA1100AKEVR (cap & adaptor kit) 305-0200AAEVR (replacement adaptor) 305XP-110ACEVR (replacement cap)
	Veeder-Root	Veeder-Root 312020-952 (cap & adaptor)
	OPW	62M-MA (GAS/E85)
Drop Tube	OPW	61-T 61T-SS (various lengths) (GAS/E85)
Tank Bottom Protector	OPW/Pomeco	6111-1400
Sump / Sump Lids / Spill Container Covers	Varies	Varies
Fuel Lock	McGard	FL1, FL2

* OPW 61JSK MFG date shall be stamped on each jack screw.

Figure 1-1
Direct Bury Spill Container OPW 1-Series (GAS/E85)

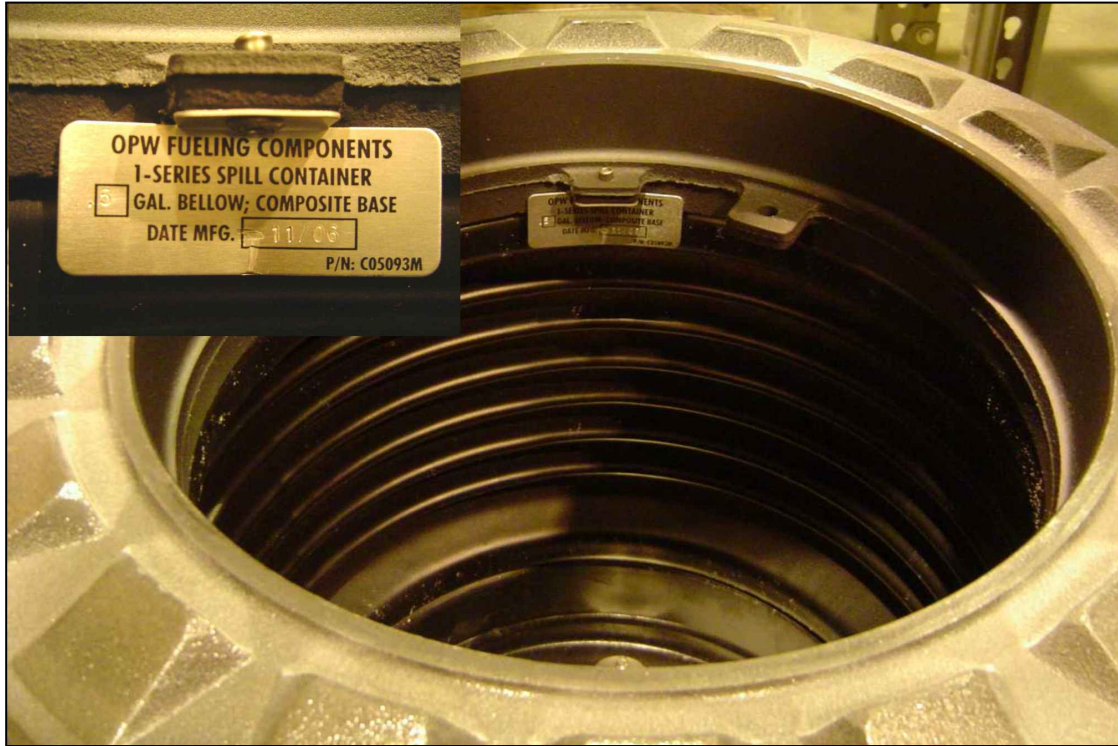

Figure 1-2
Multiport Spill Container OPW 1-Series (GAS/E85)



Figure 1-3
1DP-2100 Drain Plug Kit



Figure 1-4
1DP-2100 Field Installed Drain Plug



Figure 1-5
OPW 634LPC Product Dust Cap



Figure 1-6
OPW 1711LPC Vapor Dust Cap



Figure 1-7
OPW 634-TT-EVR Product Dust Cap

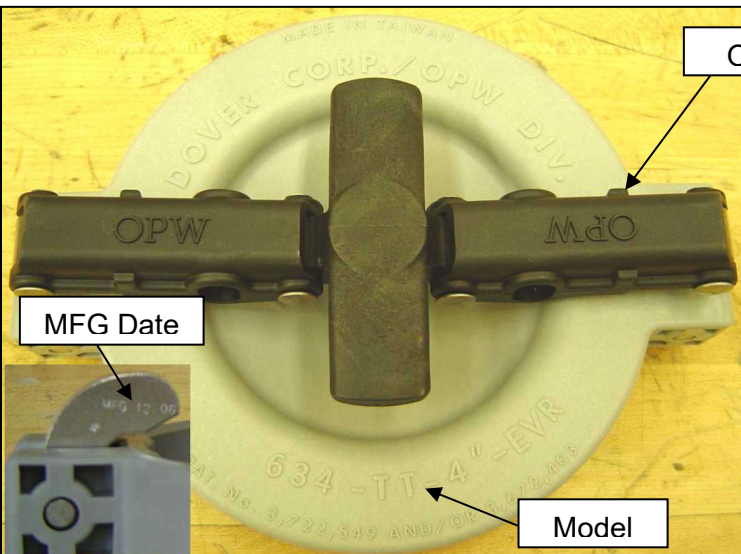

Figure 1-8
OPW 1711-T-EVR Vapor Dust Cap

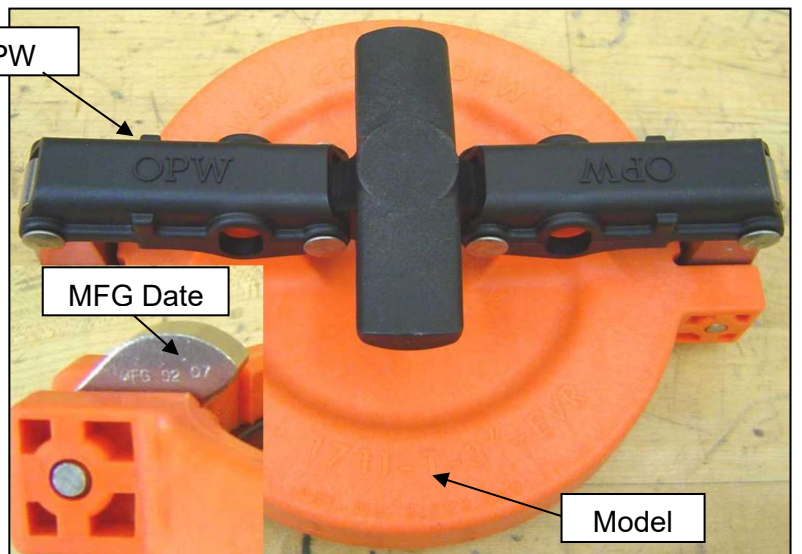

Figure 1-9
CompX CSP1-634LPC Product Dust Cap



Figure 1-10
CompX CSP3-1711LPC Vapor Dust Cap



CompX Tank Commander Lid
Locks onto CSP1-634LPC and CSP3-1711LPC Dust Caps



Figure 1-11
CompX CSP2-634LPC Product Dust Cap

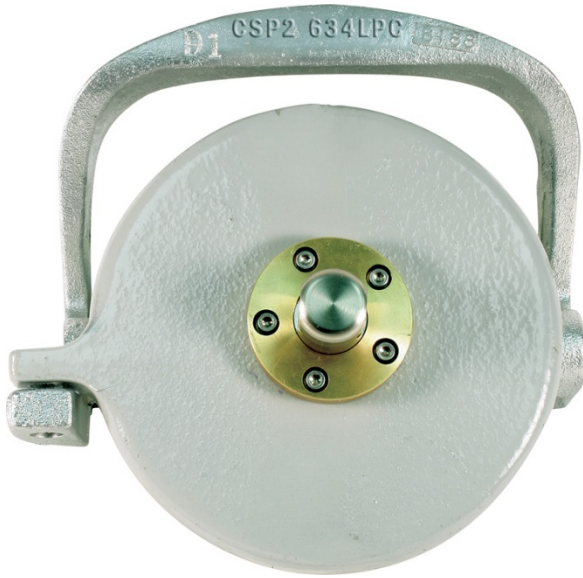

Figure 1-12
CompX CSP4-1711LPC Vapor Dust Cap



CompX Tank Commander Lid
Locks onto CSP2-634LPC and CSP4-1711LPC Dust Caps



Figure 1-13
OPW 61SALP Product Adaptor



Figure 1-14
OPW 61VSA Vapor Adaptor



Figure 1-15
OPW 61SALP-MA Product Adaptor (GAS/E85)



Figure 1-16
OPW 61VSA-MA Vapor Adaptor (GAS/E85)



Figure 1-17
FFS PV-Zero P/V Vent Valve (Gas/E85)
(Model and Serial Number on White Tag)



Figure 1-18
OPW 723V P/V Vent Valve (Gas/E85)

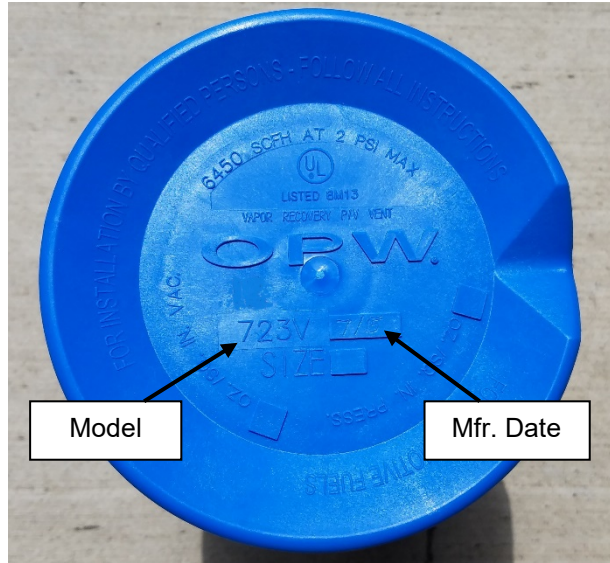

Figure 1-19
Husky 5885 P/V Vent Valve (Gas/E85)
(Husky Name on Bottom Flange)

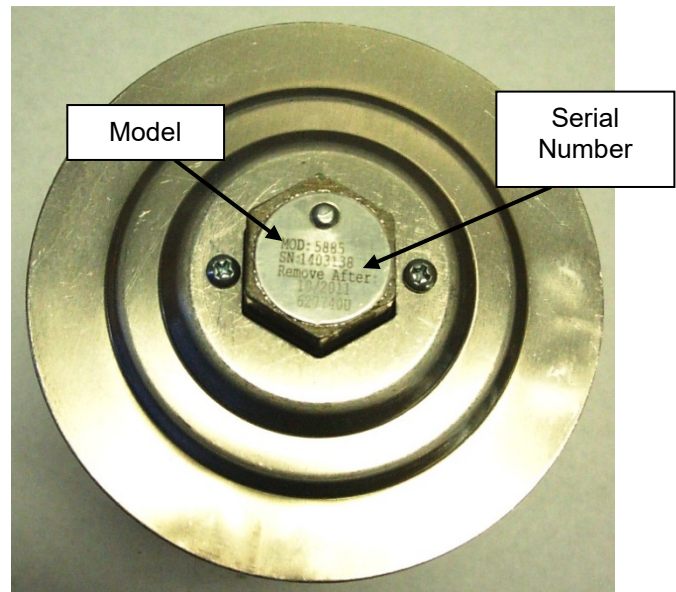

Figure 1-20
OPW 61JSK Jack Screw

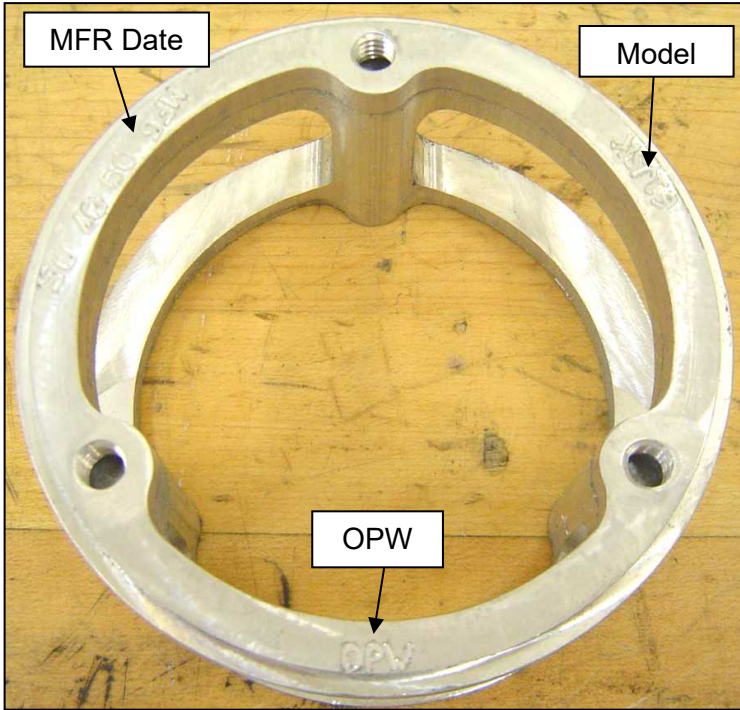

Figure 1-21
71JSK-44MA Jack Screw Kit (GAS/E85)
71JSK-4RMT Jack Screw Kit (GAS/E85)



Figure 1-22
OPW FSA-400-S Face Seal Adaptor (GAS/E85)



Figure 1-23
OPW 61SO Overfill Prevention Devices



Figure 1-24
OPW 71SO Overfill Prevention Devices



Figure 1-25
71SO Testable Drop Tube



Top View of 71SO Testable
Drop Tube



Figure 1-26
OPW 71SOM-412C Overfill Prevention Device



Figure 1-27
Defender OPV series 70859X9YZ (Gas/E85 compatible)



Defender OPV series
70859X9YZ (Gas/E85)



Model number

Serial number

**Defender OPV series
70869X9YZ (Gas/E85)
KIWA Label**

Figure 1-28
OPW 62M Cap and Adaptor
(Only Cap is identified)



Figure 1-29
OPW 62M-MA Tank Gauge Port Component (GAS/E85)



Figure 1-30
McGard Fuel Lock (FL1 on Left, FL2 on Right)



McGard Fuel Lock Installation Position³



³ Optional component, but if installed this picture shows the correct installation location in the pipe just below the Product Rotatable Adaptor in the drop tube.

This page intentionally left blank.

Exhibit 2

Installation, Maintenance, and Compliance Standards and Specifications

This exhibit contains the installation, maintenance and compliance standards, and specifications applicable to an OPW system installed in a gasoline dispensing facility (GDF).

General Specifications

1. Typical installations of the OPW system are shown in Figures 2-1 and 2-2 of the full CARB Executive Order. Typical installation of the OPW remote fill system is shown in Figures 2-4 and 2-5, and typical installation of the OPW remote additive fill system is shown in Figure 2-6 of the full CARB Executive Order.
2. The OPW system shall be installed, operated, and maintained in accordance with this attachment, applicable Oregon Administrative Rules, and manufacturer's specifications. Table 2-1 lists the maintenance intervals of OPW system components.
3. Any repair or replacement of system components shall be done in accordance with this attachment, applicable Oregon Administrative Rules, and manufacturer's specifications.
4. The OPW system shall comply with the applicable performance standards and performance specifications in Table 2-2.
5. Installation, maintenance, and repair of system components, including removal and installation of such components in the course of any required tests, shall be performed in accordance with this attachment, applicable Oregon Administrative Rules, and manufacturer's specifications.

Pressure/Vacuum Vent Valves For Storage Tank Vent Pipes -

1. No more than three certified pressure/vacuum vent valves (P/V valves) listed in Exhibit 1 shall be installed on any GDF underground storage tank system.
2. Compliance determination of the following P/V valve performance specifications shall be one of the following:
 - a. The leak rate of each P/V valve shall not exceed 0.05 cubic feet per hour (CFH) at 2.00 inches of H₂O positive pressure and 0.21 CFH at 4.00 inches of H₂O negative pressure as determined by TP-201.1E, Leak Rate and Cracking Pressure of Pressure/Vacuum Vent Valves (October 8, 2003).
 - b. The positive pressure setting is 2.5 to 6.0 inches of H₂O and the negative pressure setting is 6.0 to 10.0 inches of H₂O as determined by TP-201.1E Leak Rate and Cracking Pressure of Pressure/Vacuum Vent Valves (October 8, 2003).

3. Compliance determination of the P/V valve performance specifications in items 2a and 2b for the FFS PV-Zero P/V vent valve shall be conducted with the valve remaining in its installed position on the vent line(s). The PV-Zero portion of this attachment outlines the equipment needed to test the valve in its installed position.
4. A manifold may be installed on the vent pipes to reduce the number of potential leak sources and P/V valves installed. Vent pipe manifolds shall be constructed of steel pipe or an equivalent material that has been listed for use with gasoline. If a material other than steel is used, the GDF operator shall make available, information demonstrating that the material is compatible for use with gasoline. A tee may be located in a different position, or fewer pipes may be connected, or more than one P/V valve may be installed on the manifold.
5. Each P/V valve shall have permanently affixed to it a yellow, gold, or white colored label with black lettering stating the following specifications:

Positive pressure setting: 2.5 to 6.0 inches H₂O
Negative pressure setting: 6.0 to 10.0 inches H₂O
Positive Leakrate: 0.05 CFH at 2.0 inches H₂O
Negative Leakrate: 0.21 CFH at -4.0 inches H₂O

Rotatable Product and Vapor Recovery Adaptors

1. Rotatable product and vapor recovery adaptors shall be capable of at least 360-degree rotation and have an average static torque not to exceed 108 pound-inch (9 pound-foot). Compliance with this requirement shall be demonstrated in accordance with TP-201.1B, Static Torque of Rotatable Stage I Adaptors (October 8, 2003).
2. The vapor adaptor poppet shall not leak when closed. Compliance with this requirement shall be verified by the use of commercial liquid leak detection solution or by bagging, when the vapor containment space of the underground storage tank is subjected to a non-zero gauge pressure. (Note: leak detection solution will detect leaks only when positive gauge pressure exists.)

Vapor Recovery and Product Adaptor Dust Caps

Dust caps with intact gaskets shall be installed on all Stage I tank adaptors.

Product Spill Container Drain Valve

The spill container drain valve, if installed shall be configured to drain liquid directly into the drop tube and shall be isolated from the underground storage tank ullage space. The leak rate of the drain valve shall not exceed 0.17 CFH at 2.00 inches H₂O. Depending on the presence of the drop tube overfill prevention device, compliance with this requirement shall be demonstrated in accordance with either TP-201.1C, Leak Rate of Drop Tube/Drain Valve Assembly (October 8, 2003), or TP-201.1D, Leak Rate of Drop Tube Overfill Prevention Devices and Spill Container Drain Valves (October 8, 2003).

Product Spill Container Drain Plug (Optional)

The product spill container drain plug, either an OPW factory or field installed OPW 1DP-2100 drain plug, shall not leak. The absence of vapor leaks shall be verified with the use of commercial liquid leak detection solution (LDS) when the vapor space of the fill pipe is subjected to a positive gauge pressure.

Drop Tube Overfill Prevention Device

1. The Drop Tube Overfill Prevention Device (overfill device) is designed to restrict the flow of gasoline delivered to the underground storage tank when liquid levels exceed a specified capacity. The overfill device is not a required component of the vapor recovery system, but may be installed as an optional component. Other regulatory requirements may apply.
2. The leak rate of the overfill device shall not exceed 0.17 CFH at 2.00 inches H₂O when tested in accordance with TP-201.1D, Leak Rate of Drop Tube Overfill Prevention Devices and Spill Container Drain Valves (October 8, 2003).
3. For the 71SO Testable overfill prevention device, the threaded test plug shall not leak. The absence of vapor leaks shall be verified with the use of commercial liquid leak detection solution (LDS) when the vapor space of the underground storage tank is subjected to a positive gauge pressure.
4. The discharge opening of the fill pipe must be entirely submerged when the liquid level is six inches above the bottom of the tank as shown in Figure 2-1.

Face Seal Adaptor²

The Face Seal Adaptor shall provide a machined surface on which a gasket can seal and ensures that the seal is not compromised by an improperly cut or improperly finished riser. A Face Seal Adaptor shall be installed on the following required connections. As an option, the adaptor may be installed on other connections.

- a. Product Spill Container (required)
- b. Tank Gauging Components (required)
- c. Vapor Recovery Spill Container (optional)
- d. Rotatable Adaptors (optional)

Double Fill Configuration

OPW Double Fill Configuration shall be allowed for installation provided that no more than two fill and two vapor return points are installed on any single underground storage tank and that no offset of the vapor recovery riser pipe is installed. An example of an OPW Dual Fill configuration is shown in Figure 2-3 of the full CARB Executive Order.

² Face Seal Adaptor is not required with double wall 1-3100 and 1-2200 series spill containers.

Remote Fill Configuration

1. No liquid condensate traps are allowed with this configuration.
2. For new installations and existing installations undergoing major modifications, the Stage I vapor return piping from the remote vapor access point to the tank shall have a minimum slope of one-eighth (1/8) inch per foot of pipe run. A slope of one-quarter (1/4) inch or more per foot of pipe run is recommended wherever feasible. For existing installations, the Stage I vapor return piping from the remote vapor access point to the tank shall be installed so that any liquid in the line will drain toward the storage tank.
3. For new installations and existing installations undergoing major modifications, the Stage I vapor return piping from the remote vapor access point to the tank shall have a minimum nominal internal diameter of four inches (4" ID). For existing installations, the Stage I vapor return piping from the remote vapor access point to the tank shall have a minimum nominal internal diameter of three inches (3" ID).
4. The submerged fill pipe riser shall be fitted with a 4" pipe cap or if the submerged fill pipe riser is used as a port to manually gauge the fuel level in the UST (sticking port), a 62M cap and adaptor, as specified in Exhibit 1, shall be installed.

Remote Additive Fill Configuration

Any gasoline additive can be used only if prior to use, OPW provides a written response that the additive is compatible with the OPW Stage I system. OPW can be contacted at:

www.opwglobal.com/TechSupport/TechnicalServiceAssistance.aspx

Vapor Recovery Riser Offset

1. The vapor recovery tank riser may be offset from the tank connection to the vapor recovery Spill Container provided that the maximum horizontal distance (offset distance) does not exceed 20 inches.
2. The vapor recovery riser shall be offset up to 20 inches horizontal distance with use of commercially available, 4 inch diameter steel pipe fittings.

Tank Gauge Port Components

The tank gauge adaptor and cap are paired. Therefore, an adaptor manufactured by one company shall be used only with a cap manufactured by the same company.

Warranty

Each manufacturer listed in Exhibit 1 shall include a warranty tag with the certified component(s). The manufacturer warranty tag, included with each component, shall be provided to the service station owner/operator at the time of installation.

Connections and Fittings

All connections and fittings not specifically certified with an allowable leak rate shall not leak. The absence of vapor leaks shall be verified with the use of commercial liquid leak detection solution (LDS) or by bagging, when the vapor containment space of the underground storage tank is subjected to a non-zero gauge pressure. (Note: leak detection solution will detect leaks only when positive gauge pressure exists).

Maintenance Records

Each GDF operator or owner shall keep records of maintenance performed at the facility. Such record shall be maintained on site or otherwise readily available for review during the course of an on-site inspection. Additional information may be required in accordance with permit or OAR requirements. The records shall include the maintenance or test date, repair date to correct test failure, maintenance or test performed, affiliation, telephone number, and the name of the individual conducting maintenance or test. An example of a Stage I Maintenance Record is shown in Figure 2-3.

Table 2-1
Maintenance Intervals for System Components³
(Reference Exhibit 1 for list of certified components)

Manufacturer	Component	Maintenance Interval
OPW	Pressure/Vacuum Vent Valve	Annual
Husky	Pressure/Vacuum Vent Valve	Annual
FFS	Pressure/Vacuum Vent Valve	Annual
All Manufacturers	Tank Gauge Components	Annual
OPW	Dust Caps (all models)	Annual
CompX	Dust Caps (all models)	Annual
OPW	61-T Straight Drop Tube	Annual
OPW	Rotatable Phase I Adaptors	Annual
All Manufacturers	Drop Tube Overfill Prevention Valve	Annual
OPW	Spill Containers (all models)	Annual

Table 2-2
Gasoline Dispensing Facility Compliance Standards and Specifications

Component / System	Test Method	Standard or Specification
Rotatable Stage I Adaptors	TP-201.1B	Minimum, 360-degree rotation Maximum, 108 pound-inch average static torque
Overfill Prevention Device	TP-201.1D	≤0.17 CFH at 2.00 in H ₂ O
Spill Container Drain Valve	TP-201.1C or TP-201.1D	≤0.17 CFH at 2.00 in H ₂ O
P/V Valve	TP-201.1E	Positive pressure setting: 2.5 to 6.0 in H ₂ O Negative pressure setting: 6.0 to 10.0 in H ₂ O Positive Leakrate: 0.05 CFH at 2.0 in H ₂ O Negative Leakrate: 0.21 CFH at -4.0 in H ₂ O
Gasoline Dispensing Facility	TP-201.3	As specified in TP-201.3 and/or CP-201
Connections and fittings certified without an allowable leak rate	Leak Detection Solution or Bagging	No leaks

³ Maintenance must be conducted within the interval specified from the date of installation and at least within the specified interval thereafter.

**Figure 2-3
Example of a GDF Stage I Maintenance Record**

Date of Maintenance/ Test/Inspection/ Failure	Repair Date To Correct Test Failure	Maintenance/Test/Inspection Performed and Outcome	Affiliation	Name of Individual Conducting Maintenance or Test	Telephone Number

**Executive Order VR-102-S
Assist Stage I EVR Systems**

EXHIBIT 6

Required Items for Conducting TP-201.1C/TP-201.D on a Remote Fill System

Applicability

Exhibit 6 applies to CARB certified Stage I Remote Fill System (RFS), where the secondary product and vapor return pathway and adaptors are located in an alternate sump approximately 120 feet away from the primary product and vapor risers installed directly on top of the underground storage tanks (UST). This exhibit shall apply only to RMS with a length no greater than 200 feet. For RMS greater than 200 feet, written notification of a request for system evaluation must be submitted to DEQ. The application shall contain applicable information requested in Section 18 of the CARB Certification Procedures for Vapor Recovery Systems at Gasoline Dispensing Facilities (CP-201).

Existing Test Procedures

Sections 7.3 of TP-201.1C and section 7.5 of TP-201-1D require adjusting the nitrogen flow rate to maintain a pressure of 2.0 inches water column (WC) with a flow rate no greater than the allowable leak rate specified in CP-201. If the pressure (± 0.05 inches H₂O) cannot be maintained for at least five minutes, the system has a leak. This procedure works well when the product fill is directly above the UST for some RFS with vapor and product return lines less than 50 feet.

Procedure for Testing Remote Fill System

The TP.201.1D pressure up standard of five minutes may not be appropriate for RFS with lengths greater than 50 feet, since pressurizing the system to 2.0 inches WC may take longer than five minutes. The following steps shall be taken when conducting TP-201.1C or TP-201.1D on RFS that has a secondary product and vapor return pathway and adaptors located greater than 50 feet away. The following information shall be submitted to DEQ as part of a compliance test.

Required Steps	Verification (please circle)
Is the remote fill product adaptor less than 50 feet away from the top of the UST? If so, the maximum pressure up time shall be less than 5 minutes.	<u>Yes</u> <u>No</u>
Is the remote fill pipe lengths greater than 50 feet but less than 200 feet? See Table 1 for pressure up time.	<u>Yes</u> <u>No</u>

Test Company: _____ Facility Name: _____

Print Name (Technician) _____ Signature _____ Date _____

Technician Name
Technician Phone Number

Table 1
Time to Pressurize GDF Equipped with Remote Fill Pipe Configuration by Length

<u>Horizontal Length of Remote Fill Pipe (feet)</u>	<u>Time to Pressurize (minutes)</u>
<u>≤50</u>	<u>5</u>
<u>>50, ≤100</u>	<u>10</u>
<u>>100, ≤150</u>	<u>15</u>
<u>>150, <200</u>	<u>20</u>
<u><200, <250</u>	<u>25</u>



State of Oregon
**Department of
Environmental
Quality**

Installation, Operation and Maintenance Manual

For Executive Order

VR-102-V

OPW

Stage I Enhanced Vapor Recovery System

NOTICE:

This **Installation, Operation and Maintenance Manual for the OPW Stage I EVR System** describes the tools and methods required to install the OPW Stage I EVR System. While DEQ does not require specific certification or training to install, maintain, or repair Stage I EVR systems, owners or operators may elect to contract with certified technicians.

Note: CARB requires that only technicians trained and certified by OPW are able to perform installation, maintenance or repairs of components manufactured by OPW or the warranty will be void. A list of OPW Certified Technicians can be viewed at <http://www.opw-fc.com> .

To schedule a training class, OPW can be contacted at the following:

OPW Fueling Components
Phone: 1-800-422-2525
Web: www.opw-fc.com

It is the responsibility of each service provider or technician to be familiar with the current requirements of state, federal and local codes for installation and repair of gasoline dispensing equipment. It is also the responsibility of the service provider or technician to be aware of all necessary safety precautions and site safety requirements to assure a safe and trouble free installation.

Note: CARB requires that only technicians that are trained and certified by FFS (i.e. FFS Certified Technicians) are able to perform installation, maintenance or repairs of components manufactured by FFS or the warranty will be void. A list of FFS Certified Technicians can be viewed at <http://www.franklinfueling.com/service/>.

To schedule a training class, FFS can be contacted at the following:

Enhanced Vapor Recovery Systems
Franklin Fueling Systems
Phone: 800-225-9787
Email: techserve@franklinfueling.com

It is the responsibility of each service provider or technician to be familiar with the current requirements of state, federal and local codes for installation and repair of gasoline dispensing equipment. It is also the responsibility of the service provider or technician to be aware of all necessary safety precautions and site safety requirements to assure a safe and trouble free installation.

In addition to the requirements included in this attachment, the owner or operator of a GDF may wish to obtain a warranty tag for each stage I EVR component installed. Warranty tags are described in more detail in the CARB Executive Orders and may be included with each component for the owner or operator at the time of installation.

Summary of Guidelines for Maintenance Activities Required of the OPW Stage I EVR System ¹

Component	Interval ²	Maintenance To Be Performed
Pressure/Vacuum Vent Valve		
Husky 5885	Annual	<ol style="list-style-type: none"> 1. Remove screws that hold top cover on. 2. Remove any debris that might be sitting inside the lower cover. 3. Check the drain holes in the lower cover for blockage. 4. Do not remove the two (2) screens. 5. Reinstall the top cover and retaining screws. 6. Tighten the screws firmly.
FFS PV-Zero	Annual	<ol style="list-style-type: none"> 1. Visually inspect housing, pipe, fittings and rain cap for obvious signs of damage, missing parts or fluid leaks. 2. Visually inspect the rain cap, from ground level, for signs of bird nests or insect activity. 3. Every year, drain and inspect the fill fluid per the Fluid Inspection Procedure.
OPW 723V	Annual	<ol style="list-style-type: none"> 1. Remove and inspect filter screens. 2. Clean or replace as necessary. 3. Test as necessary.
Spill Containers and Drain Valves OPW "All Models"	Annual	Annually, clean the interior of the container and drain valve. Annually, remove accumulated dirt and grit. If the drain valve becomes clogged, remove the valve, soak in water, and use high-pressure air to clean. If valve is removed, reinstall to its proper position and perform Procedure TP-201.1C or TP-201.1D as applicable.
Dust Caps OPW "All Models"	Annual	Visually inspect the seal in cap and replace if damaged or missing.
CompX "All Models"	Annual	Inspect dust cap seal for nicks, tears or deformations and replace if necessary.
Product Adaptor OPW 61SALP	Annual inspect; test every 24 months	Visually inspect the adaptor for large dents, cracks, or deformations. Verify the static torque of the swivel adaptor by performing test procedure TP-201.1B.

¹ These maintenance requirements shall not circumvent use of the manufacturer's installation and maintenance instructions. Maintenance contractors or owner/operators shall refer to the manufacturers complete installation and maintenance instructions for the OPW Stage I System to ensure that all maintenance and torque requirements are met.

² Maintenance must be conducted within the interval specified from the date of installation and at least within the specified interval thereafter.

Summary of Guidelines for Maintenance Activities Required of the OPW Stage I EVR System ²

Component	Interval ²	Maintenance To Be Performed
Vapor Adaptor OPW 61VSA	Annual inspect; test every 24 months	Visually inspect the adaptor for large dents, cracks, or deformations. Check the vapor poppet for damage and ensure that the poppet seats evenly with the adaptor. Clean out any foreign objects from the vapor poppet's seal and seal surface if necessary. Test the poppet seal by applying a soap solution to the poppet while the underground storage tank is under a positive gauge pressure of at least 2.00 inches W.C and inspect for the presence of bubbles. If the facility continuously operates under vacuum, a bag test may be used by sealing a clear plastic bag to the adaptor's sides. If no bubbles appear at the poppet under positive pressure or the bag test shows no signs of the bag collapsing, no further maintenance is required. If bubbles appeared around the poppet seal or the bag collapsed, replace the poppet components and re-test. Verify the static torque of the swivel adaptor by performing procedure TP-201.1B.
Jack Screw Kit OPW 61JSK OPW 71JSK	Annual	Visually inspect the Jack Screw for proper alignment and installation.
Face Seal Adaptor OPW FSA-400 OPW FSA-400-S	None	No maintenance is required for this product.
Drop Tubes OPW 61T	Annual inspect; test every 24 months	Visually inspect Drop Tube to see if it is installed and ensure that the bottom of tube is within 6 inches of the bottom of tank. Test the drop tube seal with procedure TP-201.1C or TP-201.1D as applicable. If the drop tube seal passes testing, no further maintenance is required. If the drop tube seal fails testing, replace the drop tube seal with OPW P/N: H11931M for 4" Tubes. Re-test the drop tube seal with procedure TP-201.1C or TP-201.1D as applicable.

² These maintenance requirements shall not circumvent use of the manufacturer's installation and maintenance instructions. Maintenance contractors or owner/operators shall refer to the manufacturers complete installation and maintenance instructions for the OPW Stage I System to ensure that all maintenance and torque requirements are met.

² Maintenance must be conducted within the interval specified from the date of installation and at least within the specified interval thereafter.

Summary of Guidelines for Maintenance Activities Required of the OPW Stage I EVR System ³

Component	Interval ²	Maintenance To Be Performed
Drop Tube Overfill Prevention Device OPW 61SO OPW 71SO/71SO Testable	Annual inspect; test every 24 months Annual inspect; test every 24 months	Annually, inspect the flapper in the 61SO to see that it is open by looking down the drop tube opening. Test the 61SO drop tube seals with procedure TP-201.1D. If the drop tube passes testing, no further maintenance is required. If the drop tube fails testing, replace the drop tube seal with OPW P/N: H11931M for 4" Tubes. Re-test the 61SO drop tube with procedure TP-201.1D. If this does not correct the leak, the 61SO needs to be replaced. Annually, inspect the flapper in the 71SO/71SO Testable to see that it is open by looking down the drop tube opening. Test the 71SO/71SO Testable drop tube seals with procedure TP-201.1D. If the drop tube seal passes testing, no further maintenance is required. If the drop tube fails testing, replace the drop tube seal with OPW P/N: H11931M for 4" Tubes. Re-test the 71SO drop tube with procedure TP-201.1D. The lower tube o-ring seal OPW P/N: H14840M can also be replaced. If this does not correct the leak the 71SO/71SO Testable needs to be replaced.
Tank Bottom Protector OPW/POMECO 6111-1400	None	No maintenance is required for this product.
Tank Gauge Port Components OPW 62M Morrison Brothers 305 Veeder-Root 312020-952	Annual	Visually inspect cap to see that it is not missing any seals and is properly installed.

³ These maintenance requirements shall not circumvent use of the manufacturer's installation and maintenance instructions. Maintenance contractors or owner/operators shall refer to the manufacturers complete installation and maintenance instructions for the OPW Stage I System to ensure that all maintenance and torque requirements are met.

² Maintenance must be conducted within the interval specified from the date of installation and at least within the specified interval thereafter.

**OPW
EVR Stage I Equipment
Installation Check List**

Site Identification Information

Site Address:

Installing Company: _____

Certified Technician Number: _____

Technician's Name (**Print Clearly**): _____

Technician's Signature: _____

Date of Installation: _____

OPW EVR Stage I Equipment Installation Check List

Components Installed

OPW 1-Series EVR Fill Spill Containment Bucket	Yes ___	No ___
OPW 1-Series EVR Vapor Spill Containment Bucket	Yes ___	No ___
OPW FSA-400, or FSA-400-S Threaded Riser Adaptor (Face Seal Adaptor)		
On Fill Riser (Required)	Yes ___	No ___
On Tank Probe Riser (Required)	Yes ___	No ___
On Vapor Riser (Optional)	Yes ___	No ___
OPW 61SO Series Overfill Prevention Valve	Yes ___	No ___
OPW 71SO/71SO Testable Series Overfill Prevention Valve	Yes ___	No ___
OPW 61T Series Straight Drop Tube	Yes ___	No ___
OPW 61JSK Jack Screw Assembly		
61JSK-4410 (Use with composite base spill bucket)	Yes ___	No ___
61JSK-44CB (Use with cast iron base spill bucket)	Yes ___	No ___
61JSK-4RMT (Only used on Remote-Fill Applications)	Yes ___	No ___
71JSK-44MA (For use with E85 fueling facilities)	Yes ___	No ___
71JSK-4RMT (For use with E85 fueling facilities)	Yes ___	No ___
OPW 61VSA Vapor Swivel Adaptor	Yes ___	No ___
OPW 61SALP Fill Swivel Adaptor	Yes ___	No ___
OPW 634TT Top Seal EVR Fill Cap	Yes ___	No ___
OPW 1711T Top Seal EVR Vapor Cap	Yes ___	No ___
OPW 634LPC Low Profile Top Seal EVR Fill Cap	Yes ___	No ___
OPW 1711LPC Low Profile Top Seal EVR Vapor Cap	Yes ___	No ___
CompX CSP1-634LPC TuBAR Tank Commander Fill Cap	Yes ___	No ___
CompX CSP3-1711LPC TuBAR Tank Commander Vapor Cap	Yes ___	No ___
CompX CSP2-634LPC Padlock Tank Commander Fill Cap	Yes ___	No ___
CompX CSP4-1711LPC Padlock Tank Commander Vapor Cap	Yes ___	No ___
OPW 233 Extractor	Yes ___	No ___
OPW 53VML Ball Float Vent Valve	Yes ___	No ___
OPW 30MV Ball Float Vent Valve	Yes ___	No ___
OPW 62M Monitoring Probe Caps	Yes ___	No ___

Installation Acknowledgment

Installed OPW FSA-400 (-S) Threaded Riser Adaptor (Face Seal Adaptor) on fill riser and tightened to _____ ft. lb.

Thread sealant compound used _____

Installed OPW FSA-400 (-S) Threaded Riser Adaptor (Face Seal Adaptor) on tank probe riser and tightened to _____ ft. lb.

Thread sealant compound used _____

Optional

Installed OPW FSA-400 (-S) Threaded Riser Adaptor (Face Seal Adaptor) on vapor riser and tightened to _____ ft. lb.

Thread sealant compound used _____

Installed OPW 2100 Series _____, 3100 Series _____, or 500 Series _____ Fill spill containment bucket onto FSA-400 attached to fill riser and tightened to _____ ft. lb.

Thread sealant compound used _____

Installed OPW 2100 Series _____, 3100 Series _____, or 500 Series _____ vapor spill containment bucket onto vapor riser and tightened to _____ ft. lb.
 Thread sealant compound used _____

Assembled OPW 61SO Series overfill prevention valve
 Used OPW supplied epoxy Yes ___ No ___
 Applied epoxy: To upper 1" inside of top tube, under cinch head bolts and lock washers, on threads of valve body at lower tube connection. Yes ___ No ___
 Allowed epoxy to cure for 24 hours before exposure to fuel or vapor Yes ___ No ___

Installed OPW 61SO Series overfill prevention valve into fill spill containment bucket. Yes ___ No ___

Assembled OPW 71SO/71SO Testable Series overfill prevention valve Yes ___ No ___

Installed OPW 71SO/71SO Testable Series overfill prevention valve into fill spill containment bucket Yes ___ No ___

Alternative to 61SO

Installed OPW 61T Straight Drop Tube into fill spill containment bucket. Yes ___ No ___

Installed OPW 61JSK Jack Screw assembly on top of 61SO Series overfill prevention valve or on top of 61T Series Straight Drop Tube. Yes ___ No ___
 Lock-Tite applied to screws Yes ___ No ___
 Screws tightened to _____ ft. lb.

Installed faced off 4" NPT pipe nipple in fill spill containment bucket and tightened nipple to _____ ft. lb.
 Thread sealant compound used _____
 Tool used to install nipple _____

Installed faced off 4" NPT pipe nipple in vapor spill containment bucket and tightened nipple to _____ ft. lb.
 Thread sealant compound used _____
 Tool used to install nipple _____

Installed OPW 61 SALP Fill Swivel Adaptor onto faced off 4" NPT pipe nipple in fill spill containment bucket and tightened fill adaptor to _____ ft. lb.
 Thread sealant compound used _____
 Tool used to install nipple _____

Installed OPW 61 VSA Vapor Swivel Adaptor onto faced off 4" NPT pipe nipple in vapor spill containment bucket and tightened vapor adaptor to _____ ft. lb.
 Thread sealant compound used _____
 Tool used to install nipple _____

OPW 61 SA-Tool used to install OPW components Yes ___ No ___



State of Oregon
**Department of
Environmental
Quality**

Equipment and Components

Executive Order

VR-104-L
CNI Manufacturing, Inc
Stage I Enhanced Vapor Recovery System

Exhibit 1

CNI Manufacturing Stage I Vapor Recovery System Equipment List

<u>Equipment</u>	<u>Manufacturer/Model Number</u>
Containment Assembly	CNI Manufacturing XXXX-31103 (31103 denotes EVR System) 2 point System Configuration: XXXX (four digit code) indicates: CON1 – Vapor Assembly (5, 10, and 15 gallons) CON2 – Product Assembly (5, 10, and 15 gallons) Stand Alone/Direct Bury Configuration ¹ : XXXX (four digit code) indicates: 205P - Product Assembly 205V - Vapor Assembly (205 series are 5 gallons) 214P - Product Assembly 214V - Vapor Assembly (214 series are 5 gallons)
Pressure/Vacuum Vent Valve	OPW 723V FFS PV-Zero Husky 5885
Gravity Cover	CNI Mfg. GAC (used for CON1, CON2 or 214 Containments)
Snap Tight Cover	CNI Mfg. STP-200 (used for CON1, CON2 or 205 Containments)
Snap Tight Cover Ring	CNI Mfg. STP-39

¹ CNI Mfg. Stand Alone/Direct Bury Configurations 205P, 205V, 214P and 214V are not certified for use in a sump configuration.

Exhibit 1 (continued)

Drain Valve	CNI Mfg. RP12-Push
Dust Caps	CNI Mfg. 64 (product) CNI Mfg. 611-VR-3 (vapor) CompX CSP1-634LPC (product) CompX CSP3-1711LPC (vapor) CompX CSP2-634LPC (product) CompX CSP4-1711LPC (vapor) OPW 634LPC (product) OPW 1711LPC (vapor)
Dust Cap Gasket	CNI Mfg. 65 CNI Mfg. RP65 (replacement)
Product Adaptor	Emco Wheaton Retail A0030-124 Emco Wheaton Retail A0030-124S
Vapor Adaptor	Emco Wheaton Retail A0076-124 Emco Wheaton Retail A0076-124S
Jam Nut	CNI Mfg. 200JN
Tank Gauge Port Components	CNI Mfg. 613BC set (Cap 64, Adaptor 613)
Drop Tube²	CNI Mfg. DT100 (various lengths)
CNI Mfg. Drop Tube O-Ring³	CNI Mfg. DT101 (original) CNI Mfg. RP101 (replacement)
Drop Tube Overfill Prevention Valve²	EMCO Wheaton Retail A1100EVR Guardian
EMCO Wheaton Drop Tube O-Ring⁴	EMCO Wheaton Retail 569461
Fuel Lock⁵	McGard FL1 – Stick Only Fuel Lock (125007) McGard FL2 – Stick/Sampling Fuel Lock (125008)
Bladder Plug	McGard PSI104
Emergency Vent	Exhibit 5 (for below-grade vaulted tank configuration)

² If these components are installed or required by regulations of other agencies, only those components and model numbers specified above shall be installed or used.

³ O-Rings used only with the CNI Mfg. DT100 drop configuration.

⁴ O-Ring used only with the EMCO Wheaton Retail A1100EVR Guardian Overfill drop tube configuration.

⁵ If these components are installed, only those components and model numbers specified above shall be installed or used.

Exhibit 1 (continued)

**Table 1
Components Exempt from Identification Requirements**

Component Name	Manufacturer	Model Number
Replacement Drain Valve	CNI Mfg.	RP12-Push
Jam Nut	CNI Mfg.	200JN
Tank Gauge Port Components (Cap and Adaptor)	CNI Mfg.	613BC Cap and Adaptor set; p/n 64 and 613
Dust Cap gaskets	CNI Mfg.	Gasket 65 original, RP65 for replacement
O-Rings and gaskets for product and vapor adaptors	EMCO Wheaton Retail	O-rings in kit 494301, gasket 409628; O-rings in kit 493995
Drop Tube O-Ring	CNI Mfg.	DT101 original, RP101 replacement
	EMCO Wheaton Retail	56941
Drop Tube ²	CNI Mfg.	DT100
Containment Assembly	CNI Mfg.	XXXX-31103*
Gravity Cover	CNI Mfg.	CNI Mfg. GAC
Snap Tight Cover	CNI Mfg.	CNI Mfg. STP-200
Snap Tight Cover Ring	CNI Mfg.	CNI Mfg. STP-39
Fuel Lock	McGard	FL1, FL2

***CON1, CON2, 205, and 214 shall be marked on each containment assembly.**

² If these components are installed or required by regulations of other agencies, only those components and model numbers specified above shall be installed or used.

Exhibit 1 (continued)
Component Identification & Location

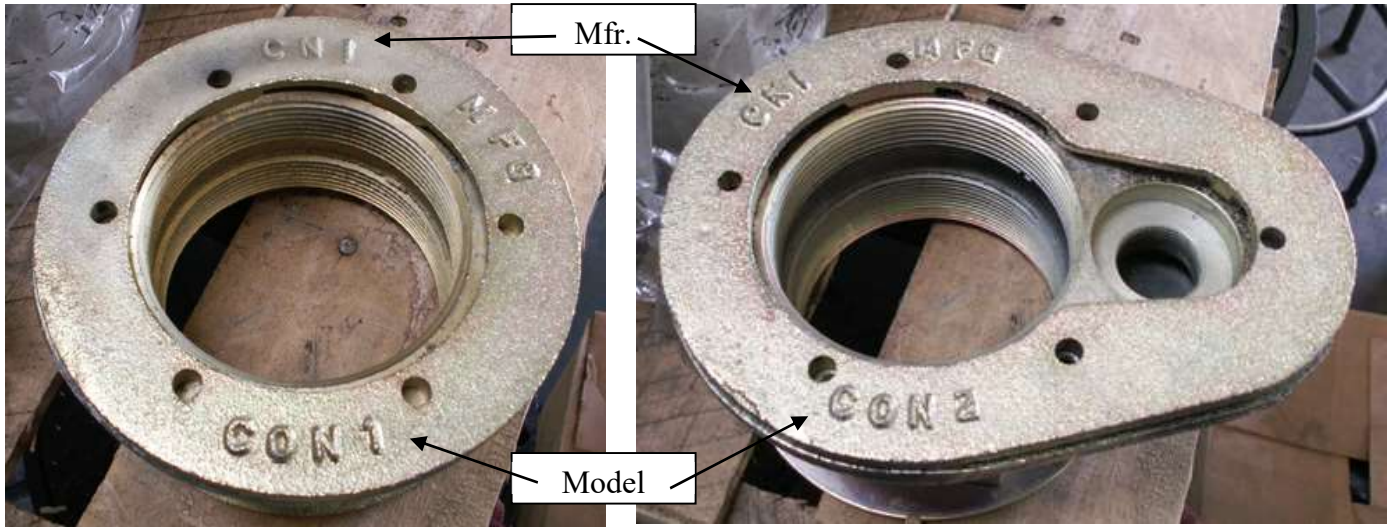

CNI Mfg. CON1 and CON2 Containment Assemblies



CNI Mfg. Model 205 and 214 Containment Assemblies

Exhibit 1 (continued)
Component Identification & Location

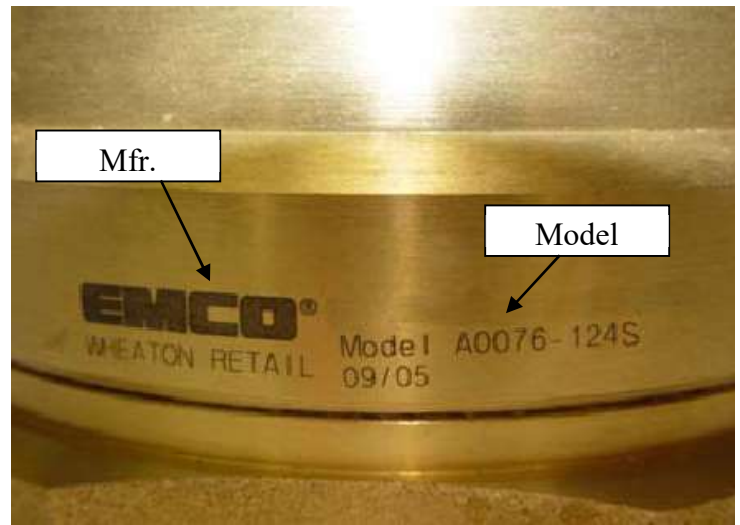
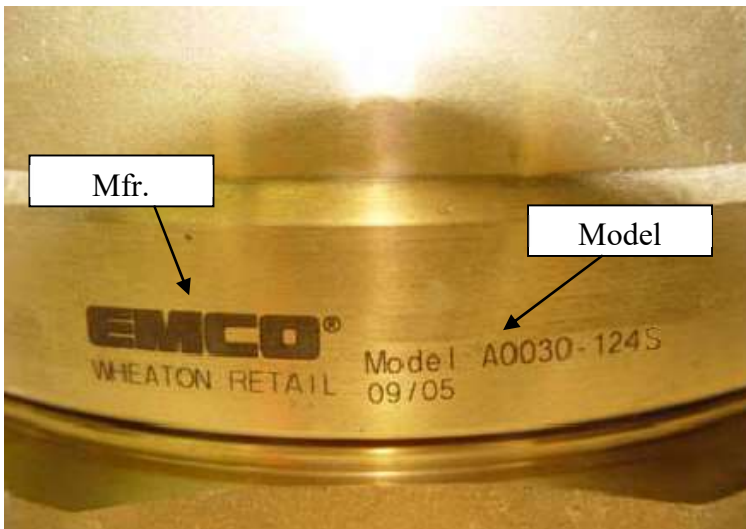

EMCO Wheaton Retail
Model A0030-124S Product Adaptor and Model A0076-124S Vapor Adaptor
(Models A0030-124 and A0076-124 identified in the same location)



EMCO Wheaton Retail
Model A1100EVR Overfill Prevention Valve

Exhibit 1 (continued)
Component Identification & Location

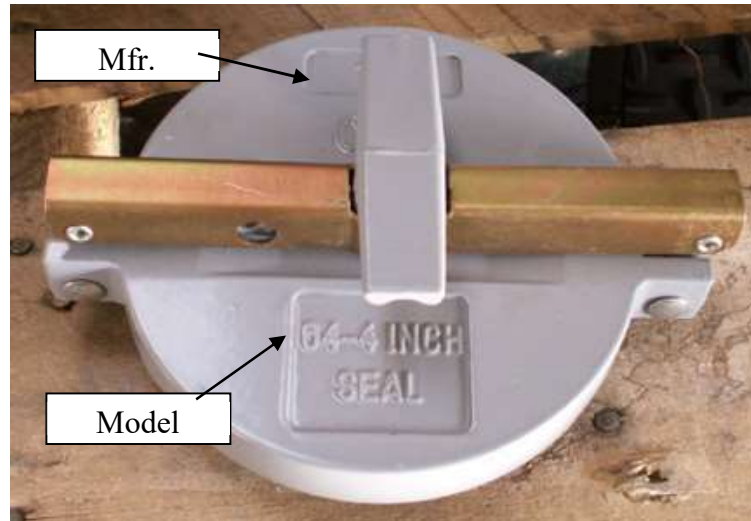

CNI Mfg. Model 64 Dust Cap

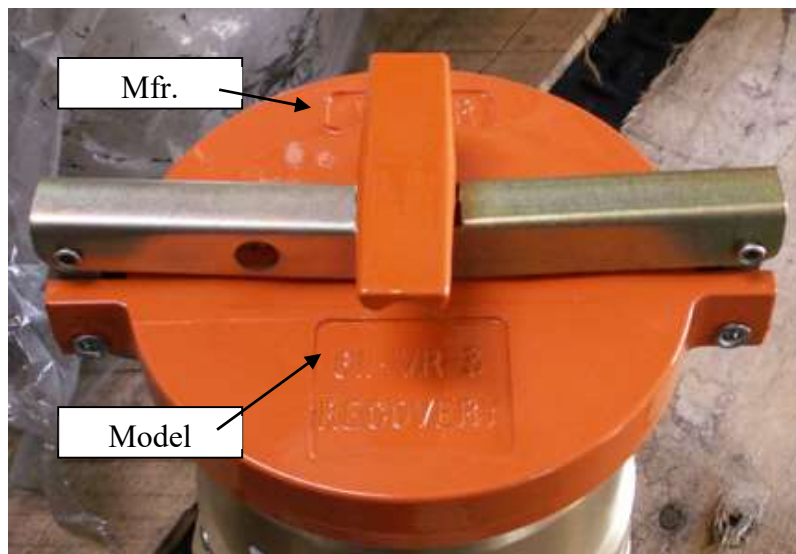

CNI Mfg. Model 611-VR-3 Dust Cap

**Exhibit 1 (continued)
Component Identification & Location**



OPW 634LPC Product Dust



OPW 1711LPC Vapor Dust

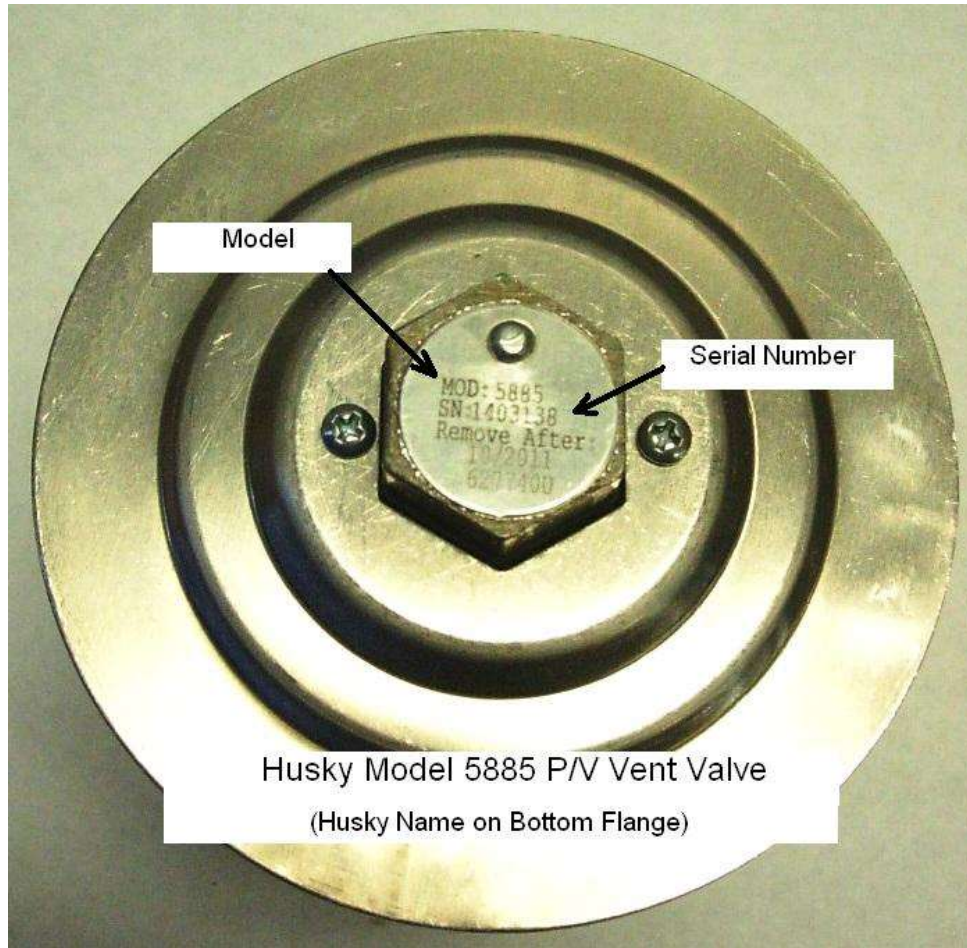

**Husky Model 5885 P/V Vent Valve
(Husky Name on Bottom Flange)**

Exhibit 1 (continued)
Component Identification and Location

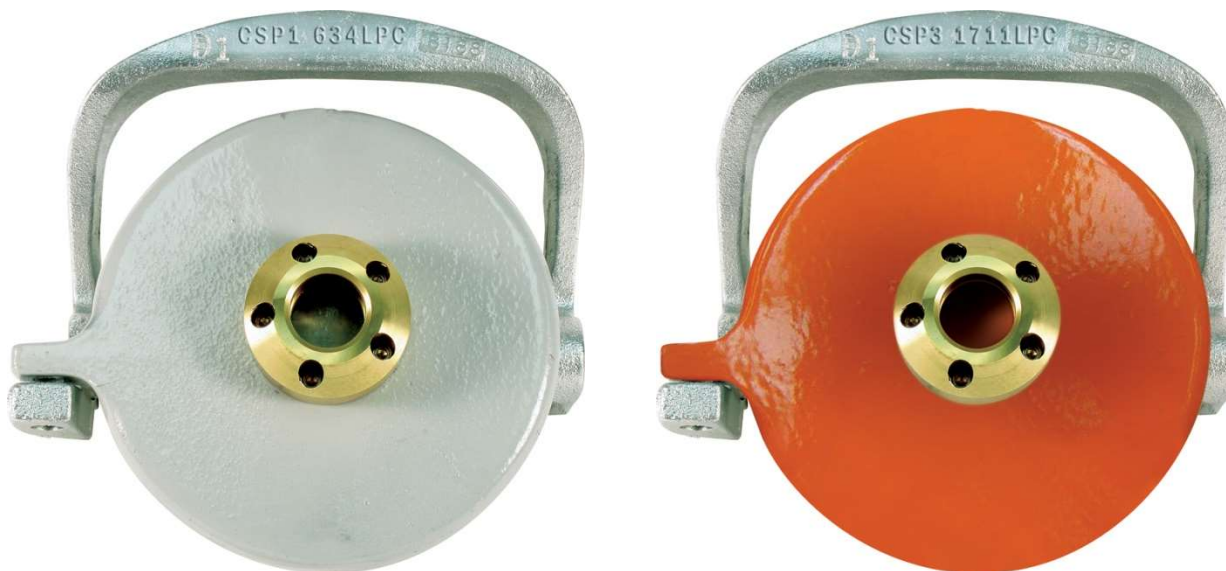

CompX CSP1-634LPC Product Dust Cap CompX CSP3-1711LPC Vapor Dust Cap



CompX Tank Commander Lid
Locks onto CSP1-634LPC and CSP3-1711LPC Dust Caps

Exhibit 1 (continued)
Component Identification and Location



CompX CSP2-634LPC Product Dust Cap

CompX CSP4-1711LPC Vapor Dust Cap



CompX Tank Commander Lid
Locks onto CSP2-634LPC and CSP4-1711LPC Dust Caps

Exhibit 1 (continued)
Component Identification and Location



FFS PV-Zero P/V Vent Valve
(Model and Serial Number on White Tag)

Exhibit 1 (continued)
Component Identification and Location



McGard Fuel Lock Installation Position⁶



McGard Fuel Lock (FL1 on Left, FL2 on Right)

⁶ Optional component, but if installed this picture shows the correct installation location in the pipe just below the Product Rotatable Adaptor in the drop tube.

Exhibit 1 (continued)
Component Identification and Location



OPW Model 723V Pressure/Vacuum Vent Valve

Exhibit 2

Installation, Maintenance and Compliance Specifications

This exhibit contains the installation, maintenance and compliance standards and specifications applicable to a CNI Manufacturing Stage I Vapor Recovery System (CNI Manufacturing System) installed in a gasoline dispensing facility (GDF).

General Specifications

1. Typical installations of the CNI Manufacturing System are shown in Figures 2A, 2B, 2C 2D, 2E, 2F, and 2G of the full CARB Executive Order.
2. The CNI Manufacturing System shall be installed, operated and maintained in accordance with this attachment, applicable Oregon Administrative Rules, and manufacturer's specifications.
3. Any repair or replacement of system components shall be done in accordance with this attachment, applicable Oregon Administrative Rules, and manufacturer's specifications.
4. Unless otherwise specified, the CNI Manufacturing Stage I Vapor Recovery System shall comply with the applicable performance standards and performance specifications in CP-201.
5. Installation, maintenance and repair of system components, including removal and installation of such components in the course of any required tests, shall be performed in accordance with this attachment, applicable Oregon Administrative Rules, and manufacturer's specifications.

Pressure/Vacuum Vent Valves For Storage Tank Vent Pipes

1. No more than three certified pressure/vacuum vent valves (P/V Valves) listed in Exhibit 1 shall be installed on any GDF underground storage tank system.
2. Compliance determination of the following P/V valve performance specifications shall be one of the following:
 - a. The leak rate of each P/V valve shall not exceed 0.05 cubic feet per hour (CFH) at 2.0 inches H₂O positive pressure and 0.21 CFH at 4.0 inches H₂O negative pressure as determined by TP-201.1E, Leak Rate and Cracking Pressure of Pressure/Vacuum Vent Valves (October 8, 2003).

- b. The positive pressure setting is 2.5 to 6.0 inches of H₂O and the negative pressure setting is 6.0 to 10.0 inches of H₂O as determined by TP-201.1E, Leak Rate and Cracking Pressure of Pressure/Vacuum Vent Valves (October 8, 2003).
3. Compliance determination of the P/V valve performance specifications in items 2a and 2b for the FFS PV-Zero P/V vent valve shall be conducted with the valve remaining in its installed position on the vent line(s). The PV-Zero section of this attachment outlines the equipment needed to test the valve in its installed position.
4. At least one pressure/vacuum (P/V) vent valve shall be installed on each tank vent. If two or more P/V vent valves are used, they shall be installed in parallel, so that each can serve as a backup to the other if one should fail to open properly. A manifold may be installed on the vent pipes to reduce the number of potential leak sources and P/V valves installed. Vent pipe manifolds shall be constructed of steel pipe or an equivalent material that has been listed for use with gasoline. If a material other than steel is used, the GDF operator shall make available information demonstrating that the material is compatible for use with gasoline. A tee may be located in a different position, or fewer vent pipes may be connected, or more than one P/V valve may be installed on the manifold.
5. Each P/V valve shall have permanently affixed to it a yellow, gold, or white-colored label with black lettering stating the following specifications:

Positive pressure setting: 2.5 to 6 inches H₂O
Negative pressure setting: 6.0 to 10.0 inches H₂O
Positive Leak rate: 0.05 CFH at 2.0 inches H₂O
Negative Leak rate: 0.21 CFH at 4.0 inches H₂O

Rotatable Product and Vapor Recovery Adaptors

1. Rotatable product and vapor recovery adaptors shall be capable of at least 360-degree rotation and have an average static torque not to exceed 108 pound-inch (9 pound-foot). Compliance with this requirement shall be demonstrated in accordance with TP-201.1B, Static Torque of Rotatable Stage I Adaptors (October 8, 2003).

Use CNI Manufacturing Torque Test Tool Part Number EVRSYS100, as an equivalent Torque Test Tool per section 5.2 of TP-201.1B, rather than Phil-Tite

Torque Test Tool Part Number 6004. The Phil-Tite tool is not compatible with CNI Manufacturing dust caps.

2. The vapor adaptor poppet shall not leak when closed. Compliance with this requirement shall be verified by the use of commercial liquid leak detection solution, or by bagging, when the vapor containment space of the underground storage tank is subjected to a non-zero gauge pressure. (Note: leak detection solution will detect leaks only when positive gauge pressure exists).

Vapor Recovery and Product Adaptor Dust Caps

Dust caps with intact gaskets shall be installed on all Stage I tank adaptors.

Spill Container Drain Valve

The spill container drain valve shall be configured to drain liquid directly into the drop tube and shall be isolated from the underground storage tank ullage space. The leak rate of the drain valve shall not exceed 0.17 CFH at 2.0 inches H₂O. Depending on the presence of the drop tube overfill prevention device, compliance with this requirement shall be demonstrated in accordance with either TP-201.1C, Leak Rate of Drop Tube/Drain Valve Assembly or TP-201.1D (October 8, 2003), Leak Rate of Drop Tube Overfill Prevention Devices and Spill Container Drain Valves (October 8, 2003).

Stage I Drop-Tubes with Overfill Prevention Devices

1. The Drop Tube Overfill Prevention Device (overfill device) is designed to restrict the flow of gasoline delivered to the underground storage when liquid levels exceed a specified capacity. The drop tube overfill device is not a required component of the vapor recovery system, but maybe installed as an optional component of the system. Other requirements may apply.
2. The leak rate of Stage I drop-tube overfill prevention devices shall not exceed 0.17 CFH at 2.0 inches H₂O). The leak rate shall be determined in accordance with TP-201.1D, Leak Rate of Drop Tube Overfill Prevention Devices and Spill Container Drain Valves (October 8, 2003).
3. The discharge opening of the fill-pipe must be entirely submerged when the liquid level is six inches above the bottom of the tank.

Stage I Drop-Tubes without Overfill Prevention Devices

1. Drop tubes that do not have an overfill prevention device shall not leak and shall be tested in accordance with TP-201.1C, Leak Rate of Drop Tube/Drain Valve Assembly (October 8, 2003).
2. The discharge opening of the fill-pipe must be entirely submerged when the liquid level is six inches above the bottom of the tank.

Vapor Recovery Riser Offset

1. The vapor recovery tank riser may be offset from the tank connection to the vapor recovery Spill Container provided that the maximum horizontal distance (offset distance) does not exceed twenty (20) inches. One example of an offset is shown in Figure 2I.
2. The vapor recovery riser shall be offset using commercially available, four (4) inch diameter steel pipe fittings.

Tank Gauge Port Components

The tank gauge adaptor and cap are paired. Therefore, an adaptor manufactured by one company shall be used only with a cap manufactured by the same company.

Warranty

Each manufacturer listed in Exhibit 1 shall include a warranty tag with the certified component(s). The manufacturer warranty tag, included with each component, shall be provided to the service station owner/operator at the time of installation.

Connections and Fittings

All connections and fittings not specifically certified with an allowable leak rate shall not leak. The absence of vapor leaks shall be verified with the use of commercial liquid leak detection solution, or by bagging, when the vapor containment space of the underground storage tank is subjected to a non-zero gauge pressure. (Note: leak detection solution will detect leaks only when positive gauge pressure exists.)

Maintenance Records

Each GDF operator/owner shall keep records of maintenance performed at the facility. Such records shall be maintained on site or otherwise readily available for review during the course of an on-site inspection. Additional information may be required in accordance with permit or OAR requirements. The records shall include the maintenance or test date, repair date to correct test failure, maintenance or test performed, affiliation, telephone number, and name of individual conducting maintenance or test. An example of a GDF Maintenance Record is shown in Figure 2J.

**Table 2-1
Gasoline Dispensing Facility Compliance Standards and Specifications**

Component/System	Test Method	Standard or Specification
Rotatable Phase I Adaptors	TP-201.1B	Minimum, 360-degree rotation Maximum, 108 pound-inch average static torque
Overfill Prevention Device	TP-201.1D	Leak rate ≤ 0.17 CFH at 2.0 inches H ₂ O
Spill Container Drain Valve	TP-201.1C or TP-201.1D	≤ 0.17 CFH at 2.0 inches H ₂ O
P/V Vent Valve	TP-201.1E	Positive pressure setting: 2.5 to 6.0 inches H ₂ O Negative pressure setting: 6.0 to 100 inches H ₂ O Positive Leak rate: 0.05 CFH at 2.0 inches H ₂ O Negative Leak rate: 0.21 CFH at -4.0 inches H ₂ O
Gasoline Dispensing Facility	TP-201.3	As specified in TP-201.3 and/or CP-201
All connections and fittings certified without an allowable leak rate	Leak Detection Solution or bagging	No Leaks

**Table 2-2
Maintenance Intervals for System Components²**

Manufacturer	Component	Maintenance Interval
OPW	Pressure/Vacuum Vent Valve	Annual
Husky	Pressure/Vacuum Vent Valve	Annual
FFS	Pressure/Vacuum Vent Valve	Annual
CNI Manufacturing	Tank Gauge Port Components	Annual Inspection
CNI Manufacturing	Dust Caps	Annual Inspection
CompX	Dust Caps	Annual Inspection
OPW	Dust Caps	Annual Inspection
CNI Manufacturing	Drop Tube	24 month Test
EMCO Wheaton Retail	Drop Tube Overfill Prevention Valve	24 month Tests
EMCO Wheaton Retail	Rotatable Phase I Product and Vapor Adaptors	24 month Tests
CNI Manufacturing	Spill Container Drain Valve	18 Months
CNI Manufacturing	Spill Containment	Annual Inspection

² Maintenance must be conducted within the interval specified from the date of installation and at least within the specified interval thereafter.

Figure 2J
Example of a GDF Maintenance Record

Date of Maintenance/ Test/Inspection/ Failure (including date and time of maintenance call)	Repair Date To Correct Test Failure	Maintenance/Test/Inspection Performed and Outcome	Affiliation	Name of Individual Conducting Maintenance or Test	Telephone Number



State of Oregon
**Department of
Environmental
Quality**

Equipment and Components

CARB Executive Order

VR-105-J

EMCO Wheaton Retail
Stage I Enhanced Vapor Recovery System

Exhibit 1

EMCO Wheaton Stage I Vapor Recovery System Equipment List

<u>Equipment</u>	<u>Manufacturer/Model Number</u>
Pressure/Vacuum Vent Valve	FFS PV-Zero Husky 5885 (Gas/E-85) OPW Model 723V
Spill Container¹	EMCO Model A1004EVR-X Series Multi-port and Direct Burial Configurations Single and Double Wall Multi-Port X= 237, 242 or 248 Direct Burial (5 gallon) X= 003, 004, 005, 006, 010, 011, 012, 013, 210A, 210AB, 210S, 210SB, 211A, 211AB, 211S, 211SB, 316A, 316S, 317A, 317AS, 317S, 317SS Direct Burial (15 gallon) X= 215A, 215AB, 215S, 215SB, 216A, 216AB, 216S, 216SB
Drain Valve²	EMCO Model 494118
Drop Tube³	EMCO Model A0020EVR-X EMCO Model A0020EVRC-X X= 004, 005, 007 or 008
Straight Drop Tube with Overfill Prevention Device	EMCO Model A1100EVR-X X= 055, 056, 057 or 058 EMCO Model A1100EVR-X (anodize tube & collar) X= 055CF, 056CF, 057CF or 058CF
Riser Seal	EMCO Model 494096
Product Adaptor	EMCO Model A0030-124S
Vapor Adaptor	EMCO Model A0076-124S

¹ Drain Valves are an optional component for Product Spill Containers. Customers can install what is traditionally considered a Vapor Spill Container (Drain Valve Port Factory Plugged) in lieu of the Product Spill Container with a drain valve.

² For Product Spill Containers that contain a drain valve, only this component and model number specified above shall be installed or used.

³ The A0020EVR has a sealing surface made by machine rolling the metal of the drop tube. The A0020EVRC has a machined collar that is installed on the drop tube.

Dust Caps

EMCO Model A0097-005 (product)
EMCO Model A0099-X (vapor)
X = 002 (no chain) or 003 (with chain)

EMCO Model A0097-004LP (product)
EMCO Model A0099-004LP (vapor)
CompX CSP1-634LPC (product)
CompX CSP3-1711LPC (vapor)
CompX CSP2-634LPC (product)
CompX CSP4-1711LPC (vapor)
OPW 634LPC (product)
OPW 1711LPC (vapor)

Tank Gauge Port Components

EMCO Model A0097-010 (Cap)
EMCO Model A0030-014 (Adaptor)

Fuel Lock⁴

McGard FL1 – Stick Only Fuel Lock (125007) (Gas)
McGard FL2 – Stick/Sampling Fuel Lock (125008)
(Gas)

Bladder Plug

McGard PSI104 (Gas)

Emergency Vent

Exhibit 5 (for below-grade vaulted tank configuration)

**Table 1
Components Exempt from Identification Requirements**

Component Name	Manufacturer	Model Number
Riser Seal	EMCO	494096
Drop Tube	EMCO	A0020EVR, A0020EVRC
Sump / Sump Lids / Spill Container Covers	Varies	Varies
Fuel Lock	McGard	FL1, FL2
Bladder Plug	McGard	PSI104

⁴ If these components are installed, only those components and model numbers specified above shall be installed or used.



EMCO Wheaton Retail Corp. Stage I EVR System Components Permanent ID Information

Spill Containment

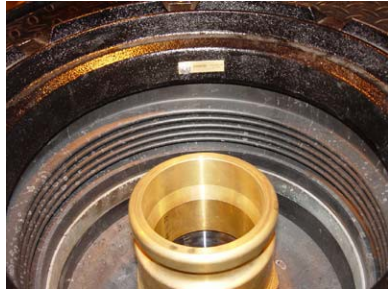

ID and Serial Number Tags for Model A1004EVR-X Series Multi-Port and Direct Burial Configurations

Drain Valve



Model 494118 Drain Valve



EMCO Wheaton Retail Corp. Stage I EVR System Components Permanent ID Information

Spill Containment



ID and Serial Number Tags for Model A1004EVR-X Series
Direct Burial Configuration with Stainless Steel Primary



Model A1004EVR-X Series Direct Burial Configuration with Stainless Steel Primary



**EMCO Wheaton Retail Corp.
Stage I EVR System Components
Permanent ID Information**

Rotatable Product Adapter



Model A0030-124S Swivel Fill Adapter

Rotatable Vapor Adapter



Model A0076-124S Swivel Vapor Adapter

Tank Gauge Port Adapter



Model A0030-014 ATG Probe Adapter



**EMCO Wheaton Retail Corp.
Stage I EVR System Components
Permanent ID Information**

Drop Tube w/ Overfill Prevention Valve



Model A1100EVR-X Series Overfill Prevention Valve

Upper Drop Tube and Collar Assembly



Non-Anodized



Anodized

Riser Seal



Model 494096 Riser Seal, Cast Iron



Model 494096 Real Seal, Stainless Steel



**EMCO Wheaton Retail Corp.
Stage I EVR System Components
Permanent ID Information**

Dust Caps



Model A0097-005 Fill Adapter Cap



Model A0099-002 and -003 Vapor Adapter Caps

Tank Gauge Port Cap



Model A0097-010 ATG Probe Adapter Cap



**EMCO Wheaton Retail Corp.
Stage I EVR System Components
Permanent ID Information**

Dust Caps



Model A0097-005 Fill Adapter Cap



Model A0099-002 and -003 Vapor Adapter Caps

Tank Gauge Port Cap



Model A0097-010 ATG Probe Adapter Cap



**EMCO Wheaton Retail Corp.
Stage I EVR System Components
Permanent ID Information**

Dust Caps



Model A0097-005 Fill Adapter Cap



Model A0099-002 and -003 Vapor Adapter Caps

Tank Gauge Port Cap



Model A0097-010 ATG Probe Adapter Cap



**EMCO Wheaton Retail Corp.
Stage I EVR System Components
Permanent ID Information**

Dust Caps



Model A0097-004LP Low Profile Fill Adapter Cap



Model A0099-004LP Low Profile Vapor Adapter Caps

**EMCO Wheaton Retail
Stage I EVR System Components
Permanent ID Information**



OPW 634LPC Product Dust



OPW 1711LPC Vapor Dust

**EMCO Wheaton Retail
Stage I EVR System Components
Permanent ID Information**



McGard Fuel Lock Installation Position⁵



McGard Fuel Lock (FL1 on Left, FL2 on Right)

⁵ Optional component, but if installed this picture shows the correct installation location in the pipe just below the Product Rotatable Adaptor in the drop tube.

**EMCO Wheaton Retail
Stage I EVR System Components
Permanent ID Information**

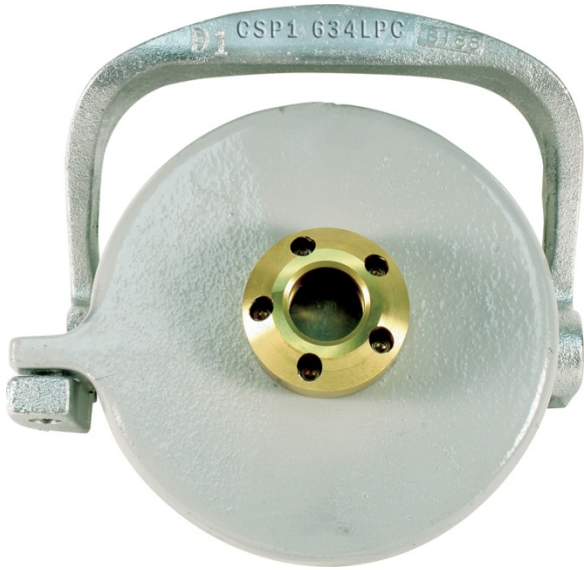

CompX CSP1-634LPC Product Dust Cap CompX CSP3-1711LPC Vapor Dust Cap



CompX Tank Commander Lid
Locks onto CSP1-634LPC and CSP3-1711LPC Dust Caps

**EMCO Wheaton Retail
Stage I EVR System Components
Permanent ID Information**

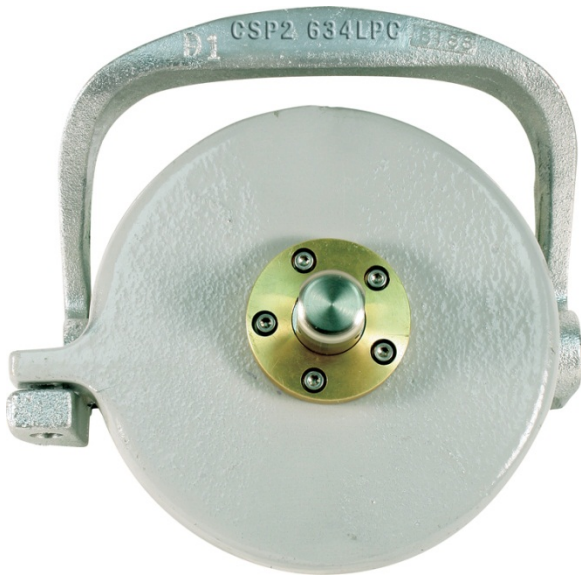

CompX CSP2-634LPC Product Dust Cap

CompX CSP4-1711LPC Vapor Dust Cap



CompX Tank Commander Lid
Locks onto CSP2-634LPC and CSP4-1711LPC Dust Caps

**EMCO Wheaton Retail
Stage I EVR System Components
Permanent ID Information**



FFS PV-Zero P/V Vent Valve
(Model and Serial Number on White Tag)

**EMCO Wheaton Retail
Stage I EVR System Components
Permanent ID Information**

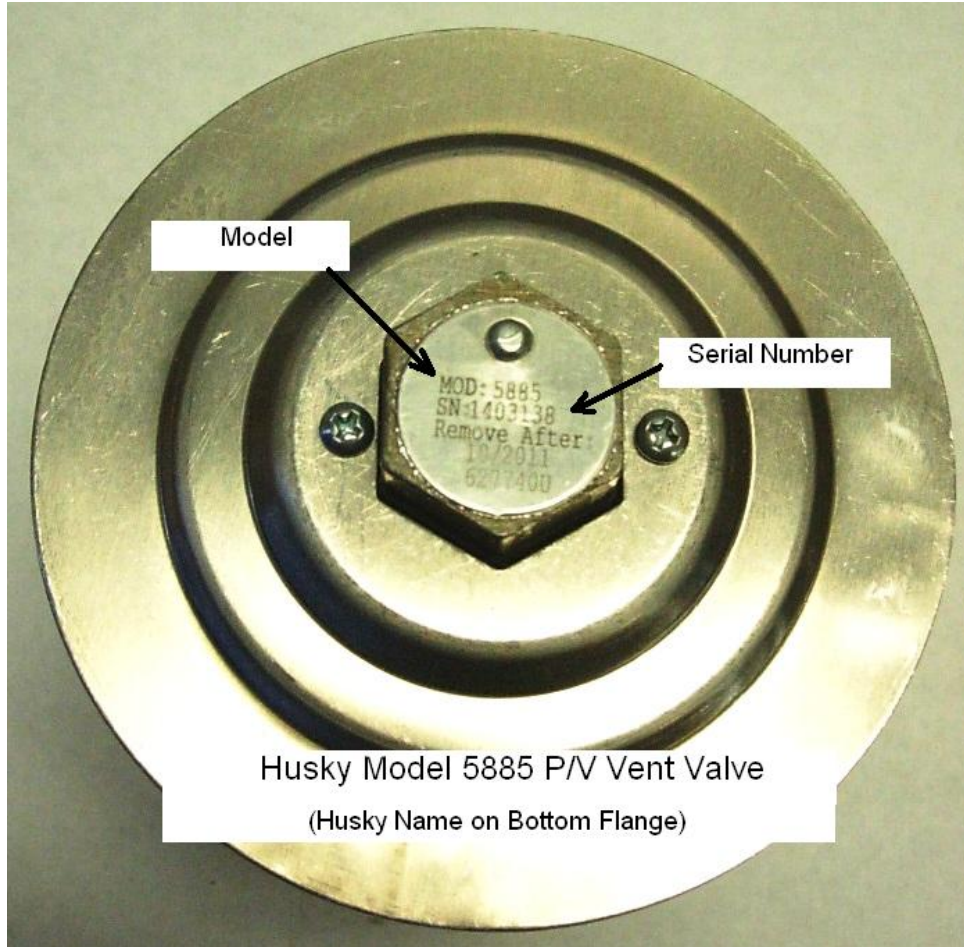

**EMCO Wheaton Retail
Stage I EVR System Components
Permanent ID Information**



OPW Model 723V P/V Vent Valve

Exhibit 2

Installation, Maintenance, and Compliance Specifications

This exhibit contains the installation, maintenance and compliance standards and specifications applicable to an EMCO Wheaton Stage I Enhanced Vapor Recovery system installed in a gasoline dispensing facility (GDF).

General Specifications

1. Typical installations of the EMCO Wheaton Stage I EVR system are shown in Figures 2A, 2B, 2C and 2D of the full CARB Executive Order.
2. The EMCO Wheaton Stage I EVR system shall be installed, operated and maintained in accordance with this attachment, applicable Oregon Administrative Rules, and manufacturer's specifications.
3. Any repair or replacement of system components shall be done in accordance with this attachment, applicable Oregon Administrative Rules, and manufacturer's specifications.
4. The EMCO Wheaton Stage I EVR system shall comply with the applicable performance standards and performance specifications in CP-201.
5. Maintenance and repair of system components, including removal and installation of such components in the course of any required tests, shall be performed in accordance with this attachment, applicable Oregon Administrative Rules, and manufacturer's specifications.

Pressure/Vacuum Vent Valves For Storage Tank Vent Pipes

1. No more than three certified pressure/vacuum vent valves (P/V Valves) listed in Exhibit 1 shall be installed on any GDF underground storage tank system.
2. Compliance determination of the following P/V valve performance specifications shall be one of the following:
 - a. The leak rate of each P/V valve shall not exceed 0.05 cubic feet per hour (CFH) at 2.0 inches of H₂O positive pressure and 0.21 CFH at -4.0 inches negative pressure as determined by TP-201.1E, Leak Rate and Cracking Pressure of Pressure/Vacuum Vent Valves (October 8, 2003).
 - b. The positive pressure setting is 2.5 to 6.0 inches of H₂O and the negative pressure setting is 6.0 to 10.0 inches of H₂O as determined by TP-201.1E, Leak Rate and Cracking Pressure of Pressure/Vacuum Vent Valves (October 8, 2003).

3. Compliance determination of the P/V valve performance specifications in items 2a and 2b for the FFS PV-Zero P/V vent valve shall be conducted with the valve remaining in its installed position on the vent line(s). The PV-Zero section of this attachment outlines the equipment needed to test the valve in its installed position.
4. A manifold may be installed on the vent pipes to reduce the number of potential leak sources and P/V valves installed. Vent pipe manifolds shall be constructed of steel pipe or an equivalent material that has been listed for use with gasoline. If a material other than steel is used, the GDF operator shall make available information demonstrating that the material is compatible for use with gasoline. A tee may be located in a different position, or fewer vent pipes may be connected, or more than one P/V valve may be installed on the manifold.
5. Each P/V valve shall have permanently affixed to it a yellow, gold, or white colored label with black lettering stating the positive and negative cracking pressures and leak rates.

Positive pressure setting: 2.5 to 6.0 inches H₂O
Negative pressure setting: 6.0 to 10.0 inches H₂O
Positive Leak rate: 0.05 CFH at 2.0 inches H₂O
Negative Leak rate: 0.21 CFH at -4.0 inches H₂O

Rotatable Product and Vapor Recovery Adaptors

1. Rotatable product and vapor recovery adaptors shall be capable of at least 360-degree rotation and have an average static torque not to exceed 108 pound-inch (9 pound-foot). Use EMCO Wheaton Torque Test Tool Part Number 494240 or any torque test tool stated in TP-201.1B. Compliance with this requirement shall be demonstrated in accordance with TP-201.1B, Static Torque of Rotatable Stage I Adaptors (October 8, 2003).
2. The vapor adaptor poppet shall not leak when closed. Compliance with this requirement shall be verified by the use of commercial liquid leak detection solution, or by bagging, when the vapor containment space of the underground storage tank is subjected to a non-zero gauge pressure. (Note: leak detection solution will detect leaks only when positive gauge pressure exists.)

Vapor Recovery and Product Adaptor Dust Caps

Dust caps with intact gaskets shall be installed on all Stage I tank adaptors.

Product Spill Container Drain Valve

The spill container drain valve is configured to drain liquid directly into the drop tube and is isolated from the underground storage tank ullage space. The leak rate of the drain valve shall not exceed 0.17 CFH at 2.00 inches H₂O. Depending on the presence of the drop tube overfill prevention device, compliance with this requirement shall be demonstrated in accordance with either TP-201.1C, Leak Rate of Drop Tube/Drain Valve Assembly (October 8, 2003), or TP-201.1D, Leak Rate of Drop Tube Overfill Prevention Devices and Spill Container Drain Valves (October 8, 2003).

Product Spill Container Factor Installed Drain Plug (Optional)

The factory installed spill container plug in the drain valve port shall not leak. The absence of vapor leaks shall be verified with the use of commercial liquid leak detection solution (LDS) when the vapor space of the fill pipe is subjected to a positive gauge pressure.

Stage I Drop-Tubes with Overfill Prevention Devices

1. The Drop Tube Overfill Prevention Device (overfill device) is designed to restrict the flow of gasoline delivered to the underground storage when liquid levels exceed a specified capacity. The drop tube overfill device is not a required component of the vapor recovery system, but maybe installed as an optional component of the system. Other requirements may apply.
2. The leak rate of Stage I drop-tube overfill prevention devices shall not exceed 0.17 CFH at 2.0 inches H₂O). The leak rate shall be determined in accordance with TP-201.1D, Leak Rate of Drop Tube Overfill Prevention Devices and Spill Container Drain Valves (October 8, 2003).
3. The discharge opening of the fill-pipe must be entirely submerged when the liquid level is six inches above the bottom of the tank.

Stage I Drop-Tubes without Overfill Prevention Devices

1. Drop tubes that do not have an overfill prevention device shall not leak and shall be tested in accordance with TP-201.1C, Leak Rate of Drop Tube/Drain Valve Assembly (October 8, 2003).
2. The discharge opening of the fill-pipe must be entirely submerged when the liquid level is six inches above the bottom of the tank.

Vapor Recovery Riser Offset

1. The vapor recovery tank riser may be offset from the tank connection to the vapor recovery Spill Container provided that the maximum horizontal distance (offset

distance) does not exceed twenty (20) inches.

2. The vapor recovery riser may be offset up to 20 inches horizontal distance with use of commercially available, four (4) inch diameter steel pipe fittings.

Tank Gauge Port Components

The tank gauge adaptor and cap are paired. Therefore, an adaptor manufactured by one company shall be used only with a cap manufactured by the same company. Figure 2E of the full CARB Executive Order shows a typical installation of tank gauge port components.

Connections and Fittings

All connections and fittings not specifically certified with an allowable leak rate shall not leak. The absence of vapor leaks shall be verified with the use of commercial liquid leak detection solution, or by bagging, when the vapor containment space of the underground storage tank is subjected to a non-zero gauge pressure. (Note: leak detection solution will detect leaks only when positive gauge pressure exists.)

Maintenance Records

Each GDF operator/owner shall keep records of maintenance performed at the facility. Such record shall be maintained on site or otherwise readily available for review during the course of an on-site inspection. Additional information may be required in accordance with permit or OAR requirements. The records shall include the maintenance or test date, repair date to correct test failure, maintenance or test performed, affiliation, telephone number, and the name of the individual conducting maintenance or test. An example of a Stage I Maintenance Record is shown in Figure 2H.

**Table 2-1
Gasoline Dispensing Facility Compliance Standards and Specifications**

Component / System	Test Method	Standard or Specification
Rotatable Phase I Adaptors	TP-201.1B	Minimum, 360-degree rotation Maximum, 108 pound-inch average static torque
Overfill Prevention Device	TP-201.1D	Leak rate ≤ 0.17 CFH at 2.00 inches H ₂ O
Spill Container Drain Valve	TP-201.1D	Leak rate ≤ 0.17 CFH at 2.00 inches H ₂ O
P/V Vent Valve	TP-201.1E	Positive pressure setting: 2.5 to 6.0 inches H ₂ O Negative pressure setting: 6.0 to 10.0 inches H ₂ O Positive Leak rate: 0.05 CFH at 2.0 inches H ₂ O Negative Leak rate: 0.21 CFH at -4.0 inches H ₂ O
Vapor Recovery System	TP-201.3	As specified in TP-201.3 and/or CP-201
All connections and fittings certified without an allowable leak rate	Leak Detection Solution or bagging	No Leaks

**Table 2-2
Maintenance Intervals for System Components²**

Manufacturer	Component	Maintenance Interval
Husky	Pressure/Vacuum Vent Valve	Annual
FFS	Pressure/Vacuum Vent Valve	Annual
OPW	Pressure/Vacuum Vent Valve	Annual
EMCO Wheaton	Tank Gauge Port Components	Annual
EMCO Wheaton	Dust Caps	Annual
CompX Security Products	Dust Caps	Annual
OPW	Dust Caps	Annual
EMCO Wheaton	Overfill Prevention Device	Annual
EMCO Wheaton	Rotatable Phase I Product and Vapor Adaptors	Annual
EMCO Wheaton	Spill Container Drain Valve	Quarterly
EMCO Wheaton	Spill Container	Quarterly and After Each Delivery

² Maintenance must be conducted within the interval specified from the date of installation and at least within the specified interval thereafter. Maintenance requirements can be found in the CARB-Approved IOM.

Figure 2H

Example of a GDF Maintenance Record

Date of Maintenance/ Test/Inspection/Failure	Repair Date To Correct Test Failure	Maintenance/Test/Inspection Performed and Outcome	Affiliation	Name of Individual Conducting Maintenance or Test	Telephone Number



State of Oregon
**Department of
Environmental
Quality**

Installation, Operation and Maintenance Manual

For Executive Order

VR-105-J
EMCO Wheaton Retail
Stage I Enhanced Vapor Recovery System

NOTICE:

This Installation, Operation and Maintenance Manual for the EMCO Wheaton Retail Stage I EVR System describes the tools and methods required to install and maintain the EMCO Stage I EVR System. While Oregon DEQ does not require specific certification or training to install, maintain, or repair stage I EVR systems, owners or operators may elect to contract with certified technicians.

Note: CARB requires that only technicians trained and certified by EMCO (i.e. EMCO Certified Technicians) are able to perform installation, maintenance or repairs of components manufactured by EMCO or the warranty will be void. A list of EMCO certified technicians can be viewed on EMCO Wheaton Retail's website at www.emcoretail.com.

To schedule a training class, EMCO can be contacted at the following:

Jose E. Rodriguez
Director of Technical Services,
CARB Liaison, West Coast Sales & Marketing
EMCO Wheaton Retail Corporation
Phone: 619-846-9882
Email: jerodriguezsd@aol.com

Note: CARB requires that only technicians trained and certified by FFS (i.e. FFS Certified Technicians) are able to perform installation, maintenance or repairs of the PV-Zero, manufactured by FFS, or the warranty will be void. A list of FFS Certified Technicians can be viewed at <http://www.franklinfueling.com/service/>

To schedule a training class, FFS can be contacted at the following:

John Covington Allan Busch, or Steve Langlie
Enhanced Vapor Recovery Systems
Franklin Fueling Systems
Phone: 800-225-9787

Email: covington@franklinfueling.com
busch@franklinfueling.com
langlie@franklinfueling.com

Note: CARB requires that only technicians trained and certified by OPW (i.e. OPW Certified Technicians) are able to perform installation, maintenance or repairs of components manufactured by OPW or the warranty will be void. A list of OPW Certified Technicians can be viewed at <http://www.opw-fc.com>.

To schedule a training class, OPW can be contacted at the following:

OPW Fueling Components
Phone: 800-422-2525
Web: www.opw-fc.com

It is the responsibility of each service provider or technician to be familiar with the current requirements of state, federal and local codes for installation and repair of gasoline dispensing equipment. It is also the responsibility of the service provider or technician to be aware of all necessary safety precautions and site safety requirements to assure a safe and trouble free installation.

Any hazardous waste generated from installation, maintenance and/or cleaning activities must be disposed of properly.

Summary of Guidelines for Maintenance Activities Required of the EMCO Wheaton Retail Stage I EVR System¹

Component

Interval

Pressure/Vacuum Vent Valve: FFS Model PV-Zero

Annually

- 1.) Visually inspect the housing, pipe, fittings and rain cap for obvious signs of damage, missing parts or fluid leaks.
- 2.) Visually inspect the rain cap from ground level for signs of bird's nests or insect activity.
- 3.) Every year drain and inspect fill fluid per the **Fluid Inspection Procedures**.

Pressure/Vacuum Vent Valve: Husky Model 5885

Annually

- 1.) Remove the screws that hold the top cover on.
- 2.) Remove any debris that might be sitting inside the lower cover.
- 3.) Check the drain holes in the lower cover for blockage.
- 4.) The two (2) screens should not be removed.
- 5.) Reinstall the top cover and retaining screws.
- 6.) Tighten the screws firmly.

OPW Model 723V

Annually

Remove and inspect filter screens – clean or replace as necessary. Test as necessary.

Upper Screen Maintenance:

See instructions on page 138 of the CARB EO IOM.

Lower Screen Maintenance:

See instructions on page 139 of the CARB EO IOM

Spill Containment: EMCO A1004EVR-X Single or Double Wall

**Quarterly &
After Each Delivery**

- 1.) Quarterly verify that the inside of the A1004EVR Spill Containment bucket is free of all dirt, gravel, debris, etc. Should cleaning be required, wipe the inside wall and bottom of the A1004EVR Spill Containment bucket using soapy water and a disposable towel.
- 2.) After each delivery, the station operator must remove any standing gasoline from the inside of the A1004EVR Spill Containment.
 - a. For spill containment buckets that do not contain a drain valve, the fuel must be removed manually. Any components that become contaminated with gasoline must be disposed of properly.
 - b. For spill containment buckets that contain the #494118 Drain Valve, if the gasoline does not drain, refer to the #494118 drain valve preventive maintenance instructions.

Drain Valve Assembly (if equipped): EMCO 494118

Quarterly

- 1.) Quarterly test the operation of the drain valve assembly by pulling up on the chain located inside the A1004EVR Spill Containment bucket.
- 2.) If gasoline does not drain when actuating the drain valve assembly perform steps (a) through (d) below:
 - a. Remove the filter from the drain valve. Using a pair of needle nose pliers, remove both cotter pins and disassemble the linkage from the top of the drain valve. Soak the filter in soapy water and use

¹ These maintenance requirements shall not circumvent use of the manufacturer's maintenance instructions. Maintenance contractors or owner/operators shall refer to the manufacturers complete installation and maintenance instructions for the EMCO Wheaton Retail System to ensure that all maintenance and torque requirements are met.

Component

Interval

**Drain Valve Assembly (if equipped):
EMCO 494118 (Continued)**

Quarterly

- high pressure air to clean and remove all debris. Replace the filter #569131 only if the screen is damaged.
- b. Using the Emco Wheaton Retail #493820 Drain Wrench unscrew the drain valve and remove from the bottom of the A1004EVR Spill Containment bucket. Soak the drain valve in soapy water and use high pressure air to clean and remove all debris. Replace the flat gasket #567108 before re-installing.
- c. To re-install the drain valve assembly, refer to installation instruction steps 3 through 5. Verify leak tightness integrity of the drain valve assembly by performing CARB test procedure TP-201.1D.
- d. If the drain valve assembly fails to pass CARB test procedure TP-201.1D, replace with new and refer to installation instructions steps 1 through 5.

Dust Caps:

EMCO A0097-005 Product

EMCO A0097-004LP Product

Annually

- 1.) Annually verify that the gasket seal is installed and properly secured and is free of tears. If cap fails to comply, replace with new cap.

EMCO A0099-X Vapor:

X=002, No Chain or 003, With Chain

EMCO A0099-004LP Vapor

Annually

- 1.) Annually verify that the gasket seal is installed and properly secured and is free of tears. If cap fails to comply, replace with new cap.

All “non-EMCO” Dust Caps :

Annually

- 1.) Visually inspect the seal in cap and replace if damaged or missing.

Product Adaptor:

EMCO A0030-124S

Every 2 years

Static Torque Test:

- 1.) Using the EMCO Wheaton Retail #494240 Swivel Adaptor Torque Wrench, every 24 months verify the static torque of the swivel adaptor by performing CARB test procedure TP-201.1B.
- 2.) If the swivel adaptor fails to meet the static torque test requirements, replace both O-rings with the EMCO Wheaton O-ring kit #494301.

Leak Tightness Integrity Test:

- 1.) Every 24 months verify leak tightness integrity of the swivel adaptor by performing CARB test procedure TP-201.1D. 2.) If the swivel adaptor fails to meet the leak tightness integrity test requirements, replace both O-rings with the EMCO Wheaton O-ring kit #494301 and/or gasket #568793.

Vapor Adaptor:

EMCO A0076-124S

Every 2 years

Static Torque Test:

- 1.) Using the EMCO Wheaton Retail #494240 Swivel Adaptor Torque Wrench, every 24 months verify the static torque of the swivel adaptor by performing CARB test procedure TP-201.1B.

Component

Interval

Vapor Adaptor:

EMCO A0076-124S (continued)

Every 2 years

- 2.) If the swivel adaptor fails to meet the static torque test requirements, replace both O-rings with the EMCO Wheaton O-ring kit #494301.

Leak Tightness Integrity Test:

- 1.) Every 24 months verify leak tightness integrity of the swivel adaptor by performing CARB test procedure TP-201.1D. 2.) If the swivel adaptor fails to meet the leak tightness integrity test requirements, replace both O-rings with the EMCO Wheaton O-ring kit #494301 and/or gasket #568793.

Extractor Assembly:

EMCO A0079-X

None Required

X=043, 044, 050, 051, 052, 150 or 152

- 1.) No preventative maintenance is required for this product.

Extractor Cage:

EMCO A0179-002

None Required

- 1.) No preventative maintenance is required for this product.

Ball Float Valve:

EMCO A0075-X

None Required

X=001, 002, 004, 006, 010, 013, 015 or 017

- 1.) No preventative maintenance is required for this product.

Riser Seal:

EMCO 494096

Every 2 years

- 1.) Every 2 years verify leak tightness integrity of the riser seal by performing CARB test procedure TP-201.1D. 2.) If the riser fails to meet the leak tightness integrity test requirements, replace the bottom O-ring with the EMCO Wheaton O-ring kit #494242.

Drop Tube Overfill Prevention Device:

EMCO A1100EVR

Annually

- 1.) Annually, conduct a visual inspection of the flapper valve assembly located inside the A1100EVR Overfill Prevention Valve. Begin by removing the spill containment lid and fill adaptor cap, looking down over the fill opening, verify that the flapper valve assembly is open and free of any foreign objects that can block or restrict the flow of gasoline into the underground storage tank during a fuel delivery.
- 2.) Every 2 years, verify leak tightness integrity of the A1100EVR Overfill Prevention Valve by performing CARB test procedure TP-201.1D.

Straight Drop Tube:

EMCO A0020EVR Flared Collar & A0020EVRC Machined Collar

Every 2 years

- 1.) Every 2 years, verify leak tightness integrity of the A0020EVR or A0020EVRC Straight Drop Tube by performing CARB test procedure TP-201.1D.
- 2.) If the A0020EVR or A0020EVRC Straight Drop Tube fails to meet the leak tightness integrity test requirements, replace the drop tube O-ring with the EMCO Wheaton O-ring kit #569461.

Component

Interval

Tank Gauge Port Components:

EMCO A0097-010 Cap

Annually

- 1.) Annually verify that the gasket seal is installed and properly secured and is free of tears. If cap fails to comply, replace with new cap.

EMCO A0030-014 Adaptor

Every 2 years

Leak Tightness Integrity Test:

- 1.) Every 2 years verify leak tightness integrity of the probe adaptor by performing CARB test procedure TP-201.3. 2.) If the probe fails to meet the leak tightness integrity test requirements, replace the gasket #568793.

Summary of Component Torque Values of the EMCO Wheaton Retail Stage I EVR System

Component	Tool Required	Torque Value
Pressure/Vacuum Vent Valve: Husky Model 5885, 2-inch threaded FFS Model PV-Zero, 3-inch threaded OPW Model 723V, 2-inch threaded	Standard Wrench and Socket Chain/Strap Wrench Standard Wrench	20 to 50 ft-lbs See Page 4 of the PV-Zero IOM Document for Specific Instructions 35 to 55 ft-lbs
Spill Containment: EMCO A1004EVR Single or Double Wall	EMCO #494241 Spill Containment Wrench	100 to 150 ft-lbs
Drain Valve Assembly: EMCO 494118	EMCO #493820 Drain Wrench	13 to 15 ft-lbs
Dust Caps: EMCO A0097-005 Product EMCO A0097-004LP Product EMCO A0099-004LP Vapor EMCO A0099-X Vapor (all models) All Non-EMCO Dust Caps	None Required None Required None Required None Required None Required	None Required None Required None Required None Required None Required
Product Adaptor: EMCO A0030-124S Base Screws (Part of A0030-124S)	EMCO #A0081-001C Adaptor Wrench Standard Wrench and Socket	60 to 75 ft-lbs 20 in-lbs
Vapor Adaptor: EMCO A0076-124S Base Screws (Part of A0076-124S)	EMCO #A0081-001C Adaptor Wrench Standard Wrench and Socket	60 to 75 ft-lbs 20 in-lbs
Extractor Assembly: EMCO A0079-X (all models)	Standard Chain Wrench with a ½ inch Off-Set	100 to 150 ft-lbs
Extractor Cage: EMCO A0179-002	EMCO #A0560-003 Extractor Wrench	25 to 35 ft-lbs
Ball Float Valve: EMCO A0075-X (all models)	Strap Wrench with a ½ inch Off-Set	15 to 25 ft-lbs
Riser Seal: EMCO Wheaton Retail #494096 Center Insert (Part of #494096)	EMCO #A0081-001C Adaptor Wrench EMCO #494120 Riser Seal Wrench	80 ft-lbs 35 to 45 ft-lbs
Drop Tube Overfill Prevention Device: EMCO A1100EVR	None Required	None Required
Straight Drop Tube: EMCO A0020EVR Flared Collar EMCO A0020EVRC Machined Collar	None Required None Required	None Required None Required
Tank Gauge Port Components: EMCO A0097-010 Cap EMCO A0030-014 Adaptor	None Required None Required	None Required 60 to 75 ft-lbs

Base Screws (Part of A0030-014)	EMCO #A0081-001C Adaptor Wrench Standard Wrench and Socket	20 in-lbs
---------------------------------	--	-----------

EMCO Wheaton Retail Stage I EVR Equipment Installation Checklist for Installing Components per CARB Executive Order VR-105

Date: _____ Signature: _____

Site Location and Name:	Installing Contractor:
Street Address:	Business Address:
City/State/Zip:	City/State/Zip:
Contact/Phone:	Contact/Phone:
Installing Technician (name):	Technician Certification Number:

Tank Number: _____ Product Grade: _____ Capacity (Gal): _____

Tank Number: _____ Product Grade: _____ Capacity (Gal): _____

Tank Number: _____ Product Grade: _____ Capacity (Gal): _____

Tank Number: _____ Product Grade: _____ Capacity (Gal): _____

Note: Because this checklist serves a dual purpose as an installation and retrofit checklist, there are some items that will be non-applicable (e.g. cut riser pipe). The technician should note “N/A” for Non-Applicable in the “Yes/No” box in those instances.

Yes/No	Initials	1. Is all the installed equipment for the Stage I EVR listed in CARB Executive Order VR-105? Note: All Phase I EVR installed equipment must be listed in an Executive Order (E.O.) If not VR-105, specify in this checklist which component was installed. .
Yes/No	Initials	2. A1004EVR Spill Containment Single or Double Wall Configurations
Yes/No	Initials	2a. Before installing the fill and vapor spill containment buckets verify that the 4 inch diameter riser pipes have been properly sized and threads cut to either NPT or BSP standards.
Yes/No	Initials	2b. Before installing the fill and vapor spill containment buckets verify that the top edges of the 4 inch diameter riser pipes have been filed flat and square with threads free of all debris to insure a proper sealing surface.
Yes/No	Initials	2c. Using a non-hardening, gasoline resistant pipe thread seal compound, manually install the fill and vapor spill containment buckets on to the 4 inch diameter riser pipes and torque between 100 – 150 ft-lbs.
Note: For installations of the EMCO A0020EVR or A0020EVRC Straight Drop Tube, proceed to Step 4.		
Yes/No	Initials	3. A1100EVR Overfill Prevention Valve (OPV) IMPORTANT: Do not apply a 45° miter cut to the very bottom of the lower drop tube.
Yes/No	Initials	3a. Has the A1100EVR OPV been properly sized for the required tank burial depth and tank riser

		pipe length?
--	--	--------------

**EMCO Wheaton Retail Stage I EVR Equipment Installation Checklist for
 Installing Components per CARB Executive Order VR-105 (Continued)**

Note: If the underground storage tank is also equipped with a ball float vent valve, the ball float vent valve cannot extend below the shut-off point of the EMCO A1100EVR overfill prevention valve.

Yes/No	Initials	3b. Has the A1100EVR collar and lower drop tube been properly assembled?
Yes/No	Initials	3c. Once completely assembled, has the A1100EVR OPV sealant cured for a minimum of 24 hours before installing into the underground storage tank (UST)?
Yes/No	Initials	A1100 EVR OPV Sealant Applied Date: _____ Time: _____
Yes/No	Initials	A1100 EVR OPV Installed into UST Date: _____ Time: _____
Yes/No	Initials	3d. Once completely assembled, has the A1100EVR OPV passed the leak tightness integrity test (≤ 0.17 cfh @ 2.00" wc) before installing into the UST?
Yes/No	Initials	3e. Before installing the A1100EVR OPV into the tank fill riser pipe, verify that the sealing O-ring is installed and properly secured. Proceed to step 5.

Note: When installing the EMCO A0020EVR or A0020EVRC Straight Drop Tube, a Ball Float Valve must be installed to serve as an overfill prevention device.

Yes/No	Initials	4. A0020EVR Flared Collar or A0020EVRC Machined Collar Straight Drop Tube IMPORTANT: Do not apply a 45° miter cut to the very bottom of the lower drop tube.
Yes/No	Initials	4a. Has the A0020EVR or A0020EVRC been properly sized for the required tank burial depth and tank riser pipe length?
Yes/No	Initials	4b. Before installing the A0020EVR or A0020EVRC into the tank fill riser pipe, verify that the sealing O-ring is installed and properly secured.
Yes/No	Initials	5. 494096 Riser Seal
Yes/No	Initials	5a. Before installing the 494096 into the fill side spill containment bucket, verify that the sealing O-ring is installed and properly secured. Torque to 80 ft-lbs.
Yes/No	Initials	5b. Has the center insert of the 494096 been manually installed and torqued between 35 – 45 ft-lbs.?
Yes/No	Initials	6. A0076-124S Vapor and A0030-124S Product Rotatable Adaptors
Yes/No	Initials	6a. Before installing the A0076-124S, verify that the top edge of the top containment nipple has

		been filed flat and square with threads free of all debris to insure a proper sealing surface.
--	--	--

**EMCO Wheaton Retail Stage I EVR Equipment Installation Checklist for
 Installing Components per CARB Executive Order VR-105 (Continued)**

Yes/No	Initials	6b. Before installing the A0076-124S and A0030-124S onto the vapor and fill spill buckets, verify that the flat gaskets for each are installed and properly secured.
Yes/No	Initials	6c. IMPORTANT: Do not use pipe thread sealant compound when installing the rotatable adaptors.
Yes/No	Initials	6d. Have the A0076-124S and A0030-124S set screws been installed with lock-tite model #222MS threadlocker and torqued to 20 in-lbs?
Yes/No	Initials	7. A0097-004LP or A0097-005 Product and A0099-004LP or A0099-002,003 Vapor Dust Caps (if using caps from a different manufacturer, write in NO and skip to section 8).
Yes/No	Initials	7a. Before installing the A0097-004LP or A0097-005 and A0099-004LP or A0099-002,003 caps onto the appropriate rotatable adaptors, verify that the gasket seals are free of tears and installed and properly secured. If a cap fails to comply, replace with new cap. Proceed to step 9.
Yes/No	Initials	8. All “non-EMCO” Product and Vapor Dust Caps (if EMCO caps are used, write in NO and skip to section 9).
Yes/No	Initials	8a. Provide the manufacturer name and model number for the product and vapor dust caps used. Refer to the appropriate section of the Installation, Operation and Maintenance Manual (IOM) for proper installation instructions.
Yes/No	Initials	Product Cap Manufacturer: _____ Model #: _____
Yes/No	Initials	Vapor Cap Manufacturer: _____ Model #: _____
Yes/No	Initials	9. A0030-014 ATG Probe Adaptor
Yes/No	Initials	9a. Before installing the A0030-014, verify that the top edge of the tank riser pipe has been filed flat and square with threads free of all debris to insure a proper sealing surface.
Yes/No	Initials	9b. Before installing the A0030-014 onto the riser pipe, verify that the flat gasket is installed and properly secured. Torque between 60 – 75 ft-lbs.
Yes/No	Initials	9c. IMPORTANT: Do not use pipe thread sealant compound when installing the ATG probe adaptor.
Yes/No	Initials	9d. Has the A0030-014 set screws been installed with lock-tite model #222MS threadlocker and torqued to 20 in-lbs.?
Yes/No	Initials	10. A0097-010 ATG Probe Adaptor Cap

**EMCO Wheaton Retail Stage I EVR Equipment Installation Checklist for
 Installing Components per CARB Executive Order VR-105 (Continued)**

Yes/No	Initials	10a. Before installing the A0097-010 onto the appropriate ATG probe adaptor, verify that the gasket seal is installed and properly secured and is free of tears.
Yes/No	Initials	10b. Has the ATG probe signal cable been properly installed and secured by manually tightening the leak tight connector nut?
Yes/No	Initials	11. A0079 Extractor Assembly (optional)
Yes/No	Initials	11a. Has the A0079 been manually installed onto the tank bung collar using a non-hardening, gasoline resistant pipe seal compound and torqued between 100 – 150 ft-lbs.?
Yes/No	Initials	12. Pressure/Vacuum Vent (P/V) Valve
Yes/No	Initials	12a. Provide the manufacturer name, model number and quantity of the P/V valve(s) installed. Refer to the appropriate section of the full CARB IOM for proper installation instructions.
Yes/No	Initials	P/V Vent Manufacturer: _____ Model: _____ Quantity: _____

FFS Model PV-Zero Pressure/Vacuum Vent Valve



PV-ZEROTM
Liquid-Filled Pressure/Vacuum Vent Valve
FFS P/N 407215901

Installation, Testing
and Maintenance Manual

Description of the FFS PV-ZERO Liquid Filled P/V Vent Valve

The PV-ZERO operates using a similar concept to a common P-Trap used in plumbing drain applications to create a liquid air seal. The liquid seals the UST ullage vapors from the atmosphere while still maintaining the proper differential pressure set-points. After the differential pressure has been exceeded, air or vapor bubbles through the liquid media until the pressure returns to the operational pressure settings. Figures 1-3 illustrate the operation of the PV-ZERO.

The PV-ZERO has no moving parts and the only maintenance required is periodic inspection of the liquid.

Because the PV-ZERO does not use seals or gaskets to seal off the UST ullage from atmosphere, the unit will not allow vapor or air to pass through at pressure less than the cracking set-point. As long as the valve is filled with 1.6 liters (54 ozs) of PV-ZERO fluid, the stainless steel valve housing is not damaged, and the pipe fittings are correctly installed, the unit should be leak free.

The liquid used for the PV-ZERO unit is silicone-based and has an very low vapor pressure and low toxicity.

The PV-ZERO can be mounted either at the top of the vent rack or in-line (mid-mount at working level). To avoid the risk of climbing a ladder and to maximize the simplicity of inspection and service, the preferred installation of the PV-ZERO is to be mounted in-line. It can be mounted on a single riser pipe or many riser pipes manifolded to a single line. The PV-ZERO is designed to mount on 3" riser piping, but can also be installed on 2" riser piping.

See drawings on pages 9-11 for mounting options.

*** Refer to CARB EVR documents regarding equipment rules for manifold systems.***

A support frame should be used for mounting all vent riser piping and must be used to stabilize the piping above the PV-ZERO if it is to be mounted in-line.

If the PV-ZERO is to be top mounted, the support frame must stabilize the piping below the unit (and the unit itself). Check local agencies for support frame requirements and consult a licensed structural engineer if in doubt of the structural integrity of the vent rack support system.

Note: Do not mount the PV-ZERO unit on a free standing vent piping system without a support frame!

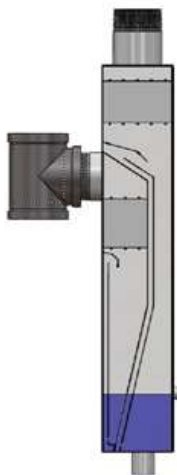

Figure 1: No Differential

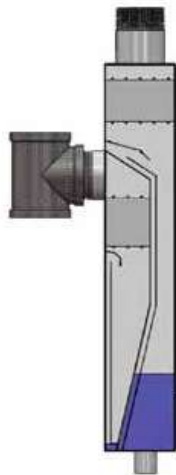

Figure 2: Positive Cracking

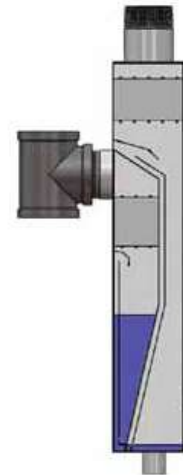

Figure 3: Negative Cracking

Installation

Note: Use a thread sealant that is approved for gasoline and gasoline-ethanol blends such as Gasoila Soft Set or Jomar Heavy Weight for all threaded pipe fittings and plugs. The 3" side tee and 1" bottom drain plug are factory installed. Tighten all fittings per recognized industry installation standards.

1. Thread the bottom of the 3" side tee onto the vent riser piping. The PV-ZERO may be mounted mid-line or top mounted on a single riser or a manifolded system (see drawings, pages 9 & 10). For 2" riser piping systems, use a 3x2" NPT reducing coupling with a 3" pipe nipple at least 6" long (see drawing, page 11).
2. Make sure the PV-ZERO unit is plumb within $\pm 3^\circ$ and not set at an angle. Failure to set in the vertical position may cause improper operation.
3. For mid-line mounting installations, install and secure the rest of the 3" discharge piping on the vent rack (refer to NFPA 30 for specific fuel system vent piping requirements). **Be sure to use a pipe wrench to counteract the tightening force to the valve!**
4. Fill the PV-ZERO unit through the side port with 1.6 liters (54 oz.) of PV-ZERO fluid (FFS p/n 407220001) provided with the unit. It may also be filled through the discharge outlet fitting (top). **Do not pour into the 3" side tee fitting!**

Note: To fill the fluid in the PV-ZERO, the UST (Underground Storage Tank) must be open to the atmosphere OR the inflatable test plug needs to be installed to reach the correct level. If the tank is under pressure or vacuum, the correct fill level cannot be obtained.

5. Install the side plug.
6. Perform the **Field Testing Procedure**.
7. Install the 3" pipe plug on top of the tee.
8. Attach the 3" upward-venting rain cap provided. Attach to the top of the vent pipe (mid-mount installation) or directly to the top of the PV-ZERO (top mount) **Keep the rain cap installed to minimize water intrusion, and to ensure proper operation.**

The PV-ZERO may be painted, however, do not paint over or cover the nameplate placards decals.

Field Testing

Note: Compliance testing of the PV-ZERO, if required by the local air quality district, shall be conducted in accordance with California Air Resources Board (CARB) test procedure TP-201.1E and Exhibit 2 of the Executive Order. This test shall be conducted using the PV-ZERO test cap assembly (FFS p/n 407225901) with the valve in its installed condition. The PV-ZERO can be tested without removing the unit from the vent rack.

There are (3) ports on the PV-ZERO test cap assembly (see page 8):

- 1 – Schrader valve connection for the inflatable plug
- 1 – 1/4" hose barb (for pressure/vacuum supply)
- 1 – 1/8" hose barb (for manometer)

1. Remove 3" pipe plug from top of tee (if necessary).
2. Install the test cap assembly through the top of the 3" tee, allowing the inflatable plug to extend into the vent riser pipe - tighten fully.
3. Inflate the inflatable plug to 35 PSI.
4. Test per CARB TP-201.1E
5. Deflate the inflatable plug.
6. Remove test cap assembly from 3" tee.

Recommended Maintenance Intervals

- **Every year:** Visually inspect the housing, pipe, fittings, and rain cap for obvious signs of damage, missing parts, or fluid leaks.
- **Every year:** Visually inspect the rain cap, from ground level, for signs of bird nests or insect activity.
- **Every year:** Drain and inspect the fill fluid per the **Fluid Inspection Procedure**.

Fluid Handling

The PV-ZERO is filled with a silicone based fluid, p/n 407220001 (contact FFS for MSDS sheet). The PV-ZERO fill fluid is resistant to UV exposure, does not support bioactivity and is resistant to oxidation.

Since the PV-ZERO is exposed to tank ullage vapors, used PV-ZERO fill fluid may contain trace amounts of ethanol and gasoline. The maintenance technician servicing the PV-ZERO should wear appropriate eye protection and nitrile gloves when inspecting or servicing the fill fluid. Check with local and state regulations regarding handling, transportation, recycling and disposal of silicone based fluids.

Fluid Inspection Procedure

1. Remove the 3" NPT plug from the top of the side tee.
2. Remove the 3/8" NPT side plug.
3. Remove the 1" NPT bottom plug and drain the fluid into a clean, transparent container.
4. Visually inspect the fill fluid for debris or water contamination. Since the specific gravity of the fluid is slightly less than water, any water in the fluid will settle to the bottom. The fluid can be reused indefinitely as long as it is free of sediment and water.

Note: Clean fluid can be refilled into the valve and topped off with new fluid, or it can be completely replaced with new fluid.

5. Reinstall the 1" NPT bottom plug.
6. Refill the PV-ZERO valve with fluid through the side-port until it spills out of the port. This is the correct fill level of 1.6 liters (54 oz.).
7. Reinstall the 3/8" NPT side plug.
8. Perform the **Field Testing Procedure**
9. Reinstall the 3" NPT plug in the top of the side tee.

Only use the approved PV-ZERO fluid (P/N 407220001). Substitution of other fluids voids the warranty and can cause vapor leaks!

PV-ZERO Specifications

Height:	33.5"
Width:	5.0"
Length:	12.3"
Dry weight:	20#
Inlet piping connection	3" NPT
Discharge piping connection	3" NPT
Fill port	3/8" NPT
Drain port	1" NPT
Construction material	304 stainless steel
Fuel Compatibility	Gas & E85
Pressure leak rate	<< 0.05CFH at +2.0 W.C.
Vacuum leak rate	<< 0.21 CFH at -4.0 W.C.
Pressure drop at 60 cfm flow rate with tank positive pressure	14" W.C.
Pressure drop at 90 cfm flow rate with tank positive pressure	28" W.C.
Minimum operating temperature	-40°F (-40°C)
Maximum operating temperature	130°F (54°C)
Maximum test pressure	5 PSI
Maximum mounting angle deviation from vertical	3°

Drawing List:

Page	Drawing Description
6	PV-ZERO Operating Assembly
7	PV-ZERO Overall Dimensions
8	Test Cap Description
9	3" Manifolder Mid Mount
10	3" Mounting Assembly
11	2" Mounting Assembly

The drawings are on the following pages.

6

<table border="1" style="width: 100%; border-collapse: collapse;"> <tr> <td style="width: 10%;">0</td> <td style="width: 15%;">1.0" RP07/DED</td> <td style="width: 50%;">*** 2x2 INPT REDUCING COUPLING</td> <td style="width: 10%;">1</td> </tr> <tr> <td>7</td> <td>RP07/DED</td> <td>--- 3" NPT INPT (MIN OF 6)</td> <td>1</td> </tr> <tr> <td>6</td> <td>407219001</td> <td>3" NPT SWLARE HEAD PIPE P-JUG</td> <td>1</td> </tr> <tr> <td>5</td> <td>407219001</td> <td>3" NPT LBE</td> <td>1</td> </tr> <tr> <td>4</td> <td>407219001</td> <td>FLUG BRASS 1" NPT</td> <td>1</td> </tr> <tr> <td>3</td> <td>407250001</td> <td>FLUG BRASS 3/8" NPT</td> <td>1</td> </tr> <tr> <td>2</td> <td>80020351</td> <td>TANK VENT ASSY 3"</td> <td>1</td> </tr> <tr> <td>1</td> <td>407203901</td> <td>PVZERO BODY ASSEMBLY</td> <td>1</td> </tr> <tr> <td>ITEM</td> <td>PART NUMBER</td> <td>DESCRIPTION</td> <td>QTY</td> </tr> </table>	0	1.0" RP07/DED	*** 2x2 INPT REDUCING COUPLING	1	7	RP07/DED	--- 3" NPT INPT (MIN OF 6)	1	6	407219001	3" NPT SWLARE HEAD PIPE P-JUG	1	5	407219001	3" NPT LBE	1	4	407219001	FLUG BRASS 1" NPT	1	3	407250001	FLUG BRASS 3/8" NPT	1	2	80020351	TANK VENT ASSY 3"	1	1	407203901	PVZERO BODY ASSEMBLY	1	ITEM	PART NUMBER	DESCRIPTION	QTY	<div style="display: flex; justify-content: space-around;"> <div style="text-align: center;"> <p>3" VENT RISER</p> </div> <div style="text-align: center;"> <p>2" VENT RISER</p> </div> </div>	<table border="1" style="width: 100%; border-collapse: collapse;"> <tr> <td style="width: 10%;">DRAWING NO:</td> <td style="width: 90%;">407215901</td> </tr> </table>	DRAWING NO:	407215901
0	1.0" RP07/DED	*** 2x2 INPT REDUCING COUPLING	1																																					
7	RP07/DED	--- 3" NPT INPT (MIN OF 6)	1																																					
6	407219001	3" NPT SWLARE HEAD PIPE P-JUG	1																																					
5	407219001	3" NPT LBE	1																																					
4	407219001	FLUG BRASS 1" NPT	1																																					
3	407250001	FLUG BRASS 3/8" NPT	1																																					
2	80020351	TANK VENT ASSY 3"	1																																					
1	407203901	PVZERO BODY ASSEMBLY	1																																					
ITEM	PART NUMBER	DESCRIPTION	QTY																																					
DRAWING NO:	407215901																																							
<p>Franklin Fueling Systems</p>																																								
<p>1 ENGINEERING RELEASE 402055 10/27/11 11/4/08</p>																																								
<table border="1" style="width: 100%; border-collapse: collapse;"> <tr> <th>REV</th> <th>DESCRIPTION</th> <th>FCN</th> <th>NO</th> <th>BY</th> <th>DATE</th> </tr> <tr> <td> </td> <td> </td> <td> </td> <td> </td> <td> </td> <td> </td> </tr> </table>				REV	DESCRIPTION	FCN	NO	BY	DATE																															
REV	DESCRIPTION	FCN	NO	BY	DATE																																			
<table border="1" style="width: 100%; border-collapse: collapse;"> <tr> <td style="width: 50%;">TITLE</td> <td style="width: 50%;">PV-ZERO OPERATING ASSEMBLY</td> </tr> <tr> <td>GRAPHIC DATE</td> <td>11/14/08</td> </tr> <tr> <td>GRAPHIC NO</td> <td>407215</td> </tr> <tr> <td>SCALE</td> <td>1:1</td> </tr> <tr> <td>SHEET NO</td> <td>OF 1</td> </tr> </table>				TITLE	PV-ZERO OPERATING ASSEMBLY	GRAPHIC DATE	11/14/08	GRAPHIC NO	407215	SCALE	1:1	SHEET NO	OF 1																											
TITLE	PV-ZERO OPERATING ASSEMBLY																																							
GRAPHIC DATE	11/14/08																																							
GRAPHIC NO	407215																																							
SCALE	1:1																																							
SHEET NO	OF 1																																							
<p><small>This information is a trade secret. It is intended for use only by those personnel who are authorized to receive it. It is not to be distributed, copied, or used in any way without the express written permission of Franklin Fueling Systems. This drawing is for informational purposes only. It is not to be used for manufacturing or repair purposes without the express written permission of Franklin Fueling Systems.</small></p>																																								
<p>SEE BOM</p> <p>FOR MATERIAL LIST</p> <p>FOR DIMENSIONS</p> <p>FOR TOLERANCES</p> <p>(UNLESS OTHERWISE SPECIFIED)</p> <p>ANGULAR ± 1/2°</p> <p>FINISH AS SHOWN</p> <p>UNLESS OTHERWISE SPECIFIED</p> <p>ALL DIMENSIONS IN INCHES</p> <p>UNLESS OTHERWISE SPECIFIED</p> <p>ALL DIMENSIONS IN MILLIMETERS</p> <p>UNLESS OTHERWISE SPECIFIED</p>																																								

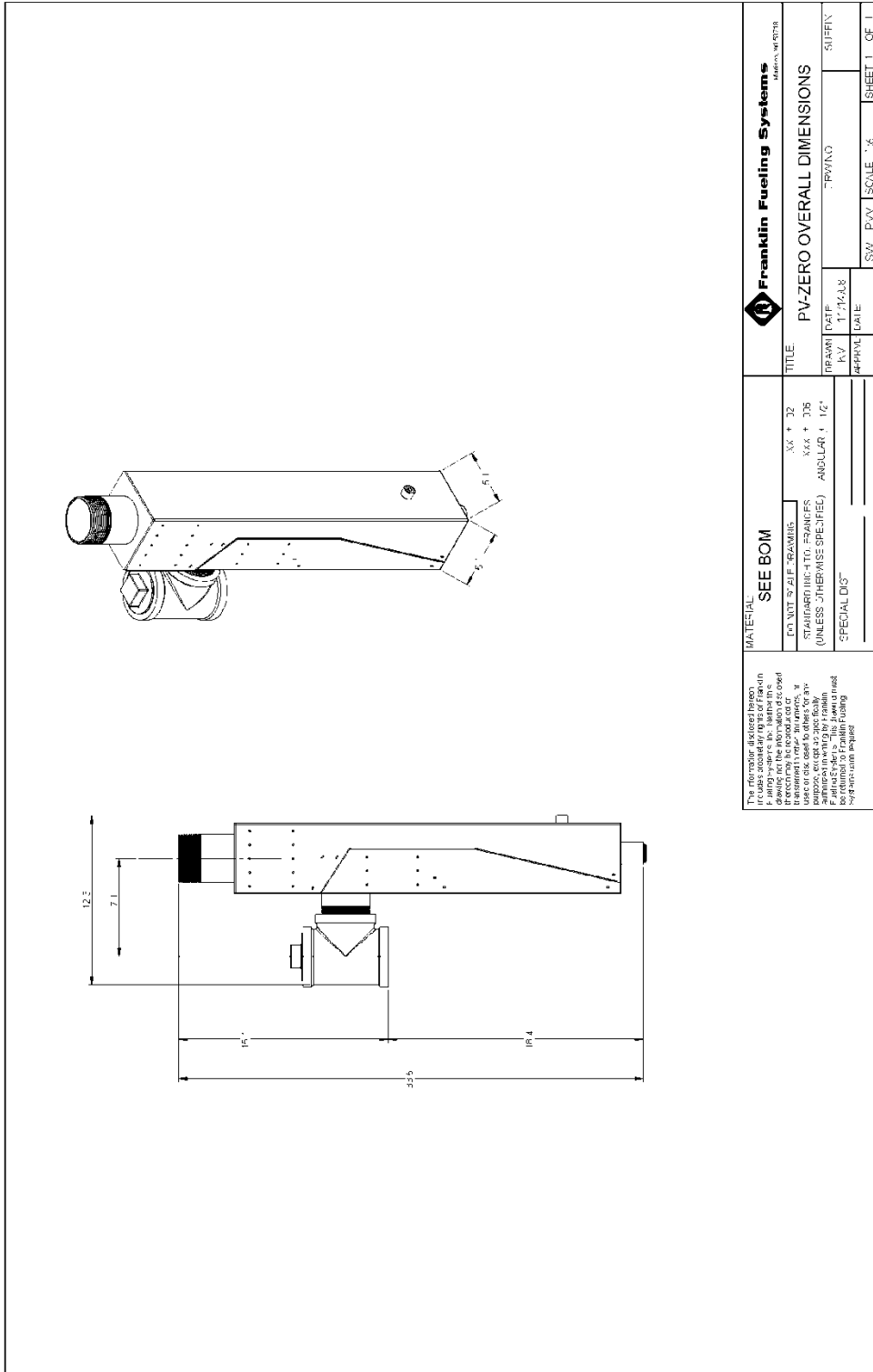

<p>The information depicted herein includes secondary rights of Franklin Fueling Systems, Inc. and is provided for the information of the user. It is not to be used for any purpose, except as specifically authorized by Franklin Fueling Systems, Inc.</p>		<p>SEE BOM</p> <p>DO NOT SCALE DRAWINGS</p> <p>STANDARD (INC. TO FRANKLIN) (UNLESS OTHERWISE SPECIFIED)</p> <p>SPECIAL DIS</p>	<p>Franklin Fueling Systems <small>MADE IN THE U.S.A.</small></p> <p>PV-ZERO OVERALL DIMENSIONS</p>
<p>TITLE</p> <p>XXXX + 02</p> <p>XXXX + 006</p> <p>ANGULAR 1/2"</p>		<p>DATE</p> <p>1-16-2018</p> <p>SCALE 1/8"</p>	<p>SHEET 1 OF 1</p>

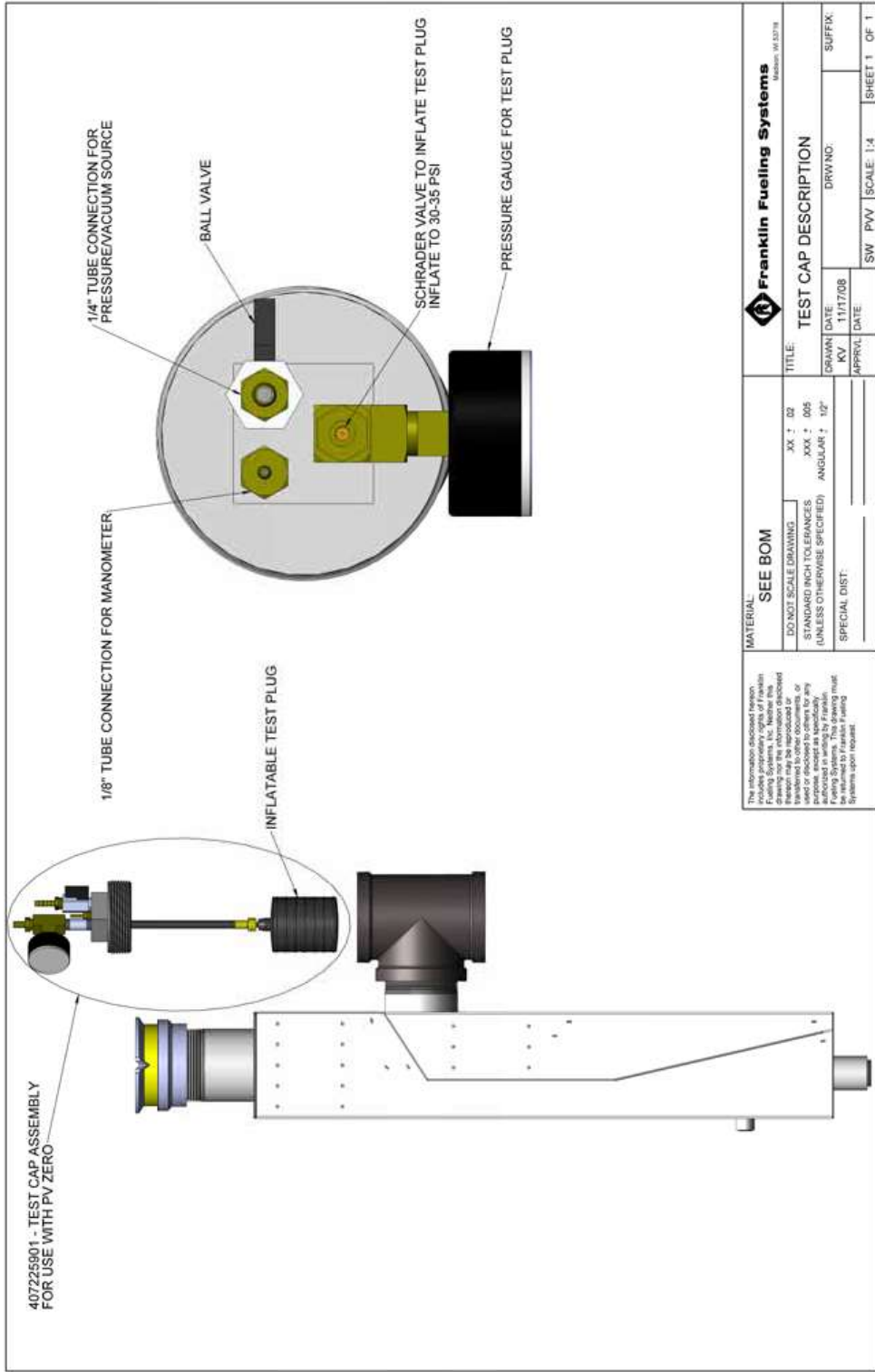

8

<p>The information disclosed herein includes proprietary rights of Franklin Fueling Systems, Inc. Neither the information nor the design or method of operation may be reproduced or transmitted in any form or by any means, electronic or mechanical, including photocopying, recording, or by any information storage or retrieval system, without the prior written permission of Franklin Fueling Systems, Inc. This drawing must be returned to Franklin Fueling Systems upon request.</p>		<p>Franklin Fueling Systems Revision: 04.23.18</p>	
<p>MATERIAL: SEE BOM</p>		<p>TITLE: TEST CAP DESCRIPTION</p>	
<p>DO NOT SCALE DRAWING</p>	<p>XX : 02</p>	<p>DRAWN DATE</p>	<p>DRW NO.</p>
<p>STANDARD INCH TOLERANCES</p>	<p>XXX : 005</p>	<p>KV</p>	<p>SUFFIX</p>
<p>(UNLESS OTHERWISE SPECIFIED)</p>	<p>ANGULAR : 10°</p>	<p>APPROV. DATE</p>	<p>SCALE: 1/4"</p>
<p>SPECIAL DIST:</p>		<p>SW</p>	<p>PW</p>
		<p>SHEET 1</p>	<p>OF 1</p>

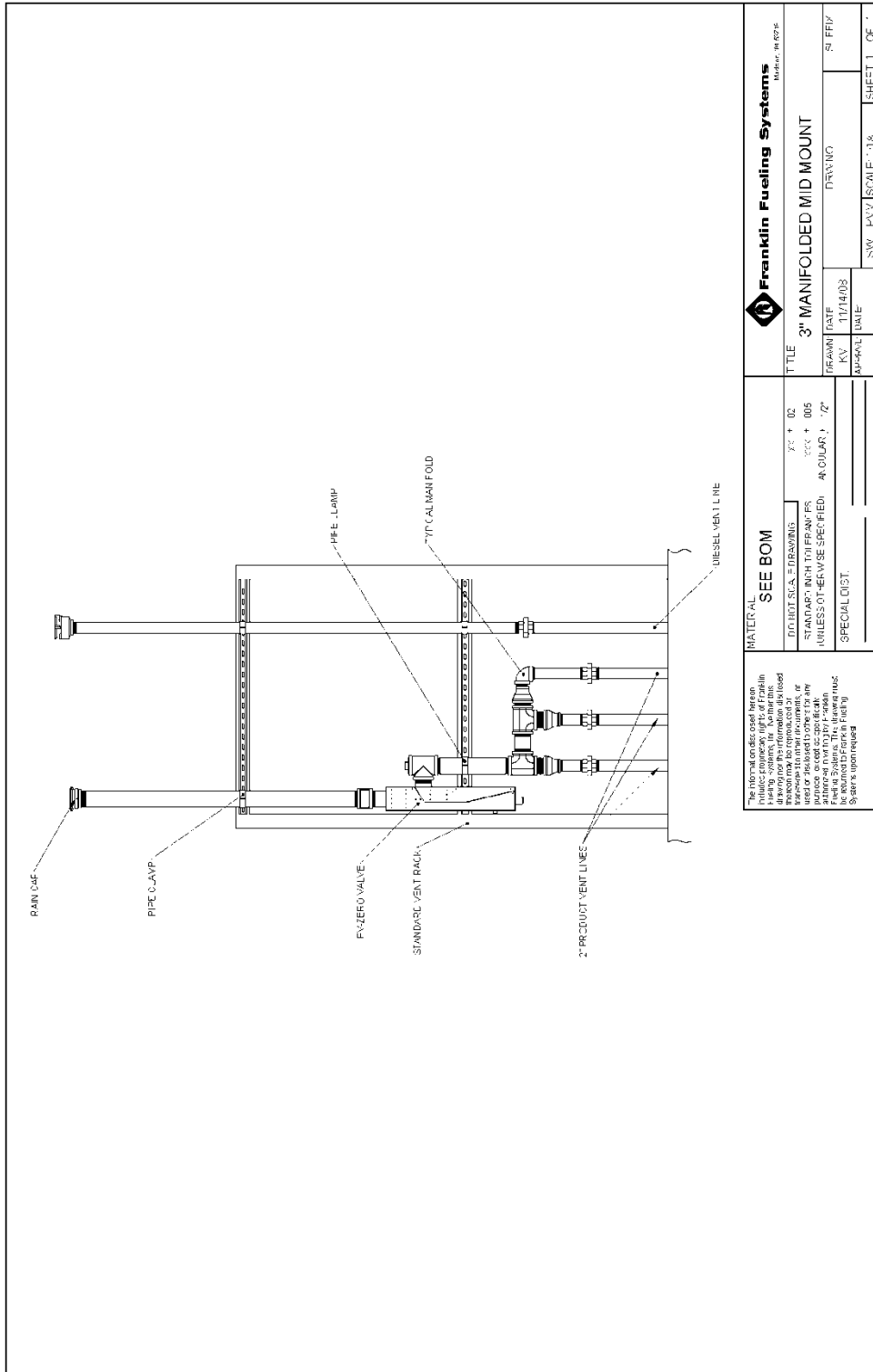

<p>The information described herein is the property of Franklin Fueling Systems, Inc. It is to be used only for the specific application and for the information provided. It is not to be reproduced or transmitted in any form or by any means, electronic, mechanical, photocopying, recording, or by any information storage and retrieval system, without the prior written permission of Franklin Fueling Systems, Inc.</p>	<p>SEE BOM</p>	
	<p>DATE: 03/17/03</p>	<p>REV: 002</p>
<p>MATERIAL</p>	<p>STANDARD: 3" MANIFOLDED MID MOUNT</p>	<p>FRANKLIN FUELING SYSTEMS, INC.</p>
<p>SEE BOM</p>	<p>DATE: 03/17/03</p>	<p>REV: 002</p>
<p>SPECIALIST:</p>	<p>DATE: 03/17/03</p>	<p>REV: 002</p>

<p>Franklin Fueling Systems <small>Member, OPW</small></p>	<p>3' MANIFOLDED MID MOUNT</p>
<p>DATE: 03/17/03</p>	<p>REV: 002</p>
<p>SCALE: 1:16</p>	<p>SHEET 1 OF 1</p>

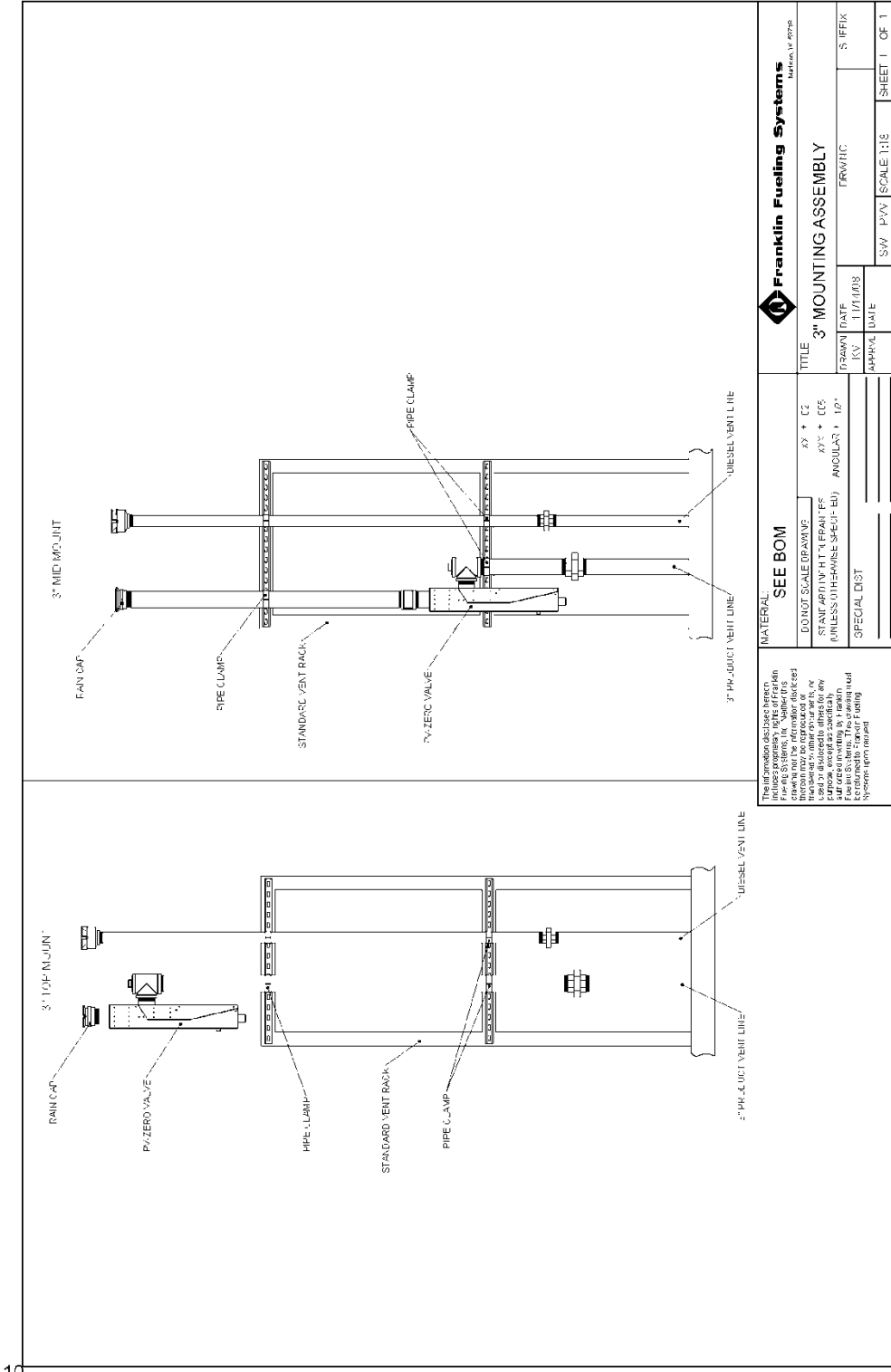

10

Franklin Fueling Systems <small>Part No. 10298</small>	
3" MOUNTING ASSEMBLY	
DATE: 11/11/08	SCALE: 1:18
DESIGNER: S. IFFIK	
APPROVAL: _____	SHEET 1 OF 1

SEE BOM	
DO NOT SCALE DRAWING	X7 + C2
STANDARD DRAWING	X77 + C65
(UNLESS OTHERWISE SPECIFIED)	ANGULAR ± 1/2°
SPECIAL LIST	

The information contained herein includes proprietary rights and is not to be reproduced, stored in a retrieval system, or transmitted in any form or by any means, electronic, mechanical, photocopying, recording, or by any information storage and retrieval system, without the prior written permission of Franklin Fueling Systems. This drawing may be used for reference only. All other rights reserved.

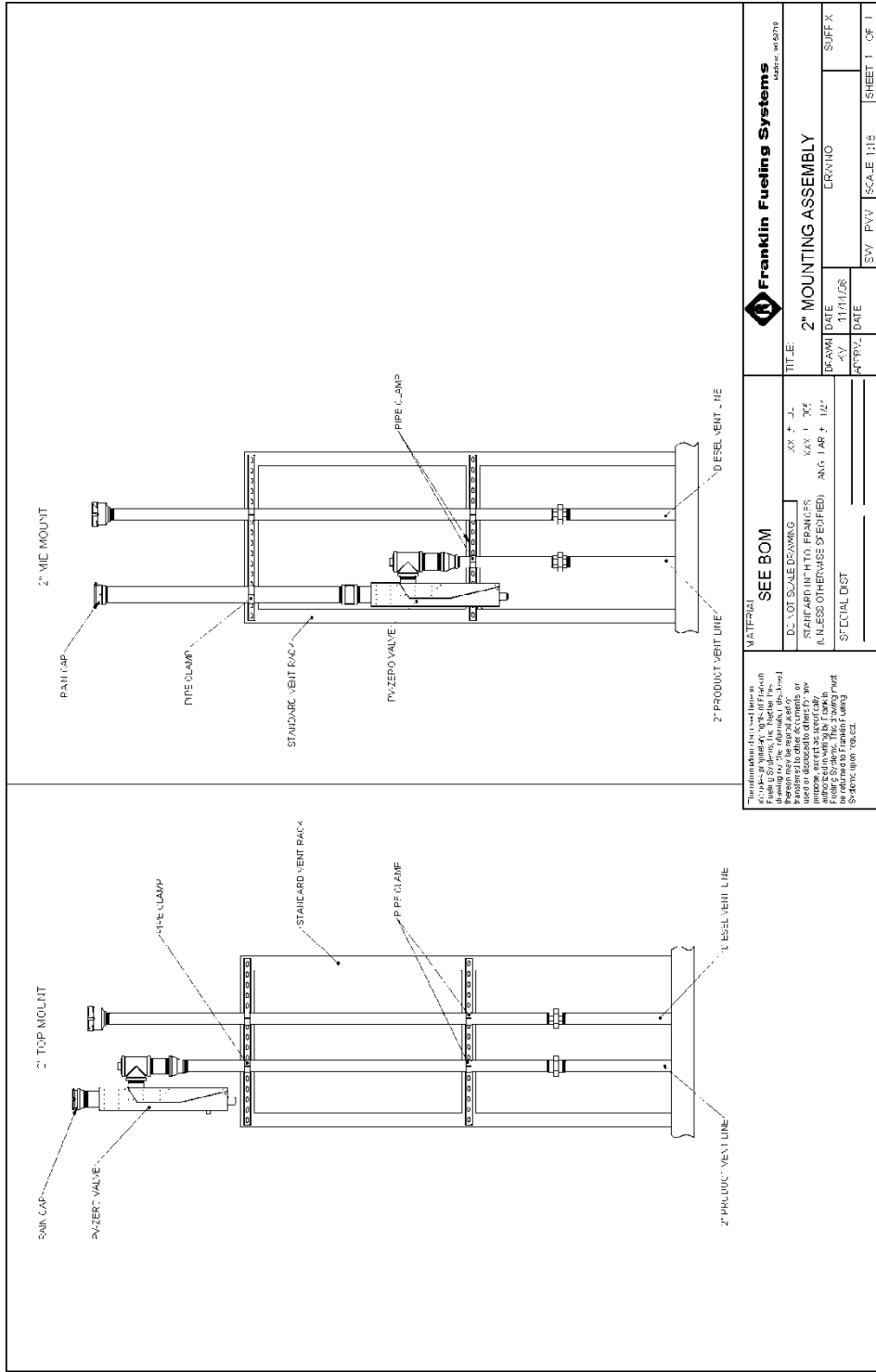

The information on this drawing was prepared by Franklin Fueling Systems, Inc. The design, engineering, and manufacturing of the product are the property of Franklin Fueling Systems, Inc. All rights reserved. No part of this drawing may be reproduced or transmitted in any form or by any means, electronic, mechanical, photocopying, recording, or by any information storage and retrieval system, without the prior written permission of Franklin Fueling Systems, Inc. This drawing is for informational purposes only and does not constitute a contract. All dimensions are in inches unless otherwise specified. All dimensions are to be taken from the finished product. All dimensions are to be taken from the finished product. All dimensions are to be taken from the finished product.

MATERIAL		SEE BOM	SCALE DRAWING	SVY + JLN
D.L. OF SCALE DRAWING		SVY + JLN	SVY + JLN	SVY + JLN
STANDARD UNIT OF MEASUREMENT		INCHES	INCHES	INCHES
UNLESS OTHERWISE SPECIFIED		ANSI Y14.5	ANSI Y14.5	ANSI Y14.5
SPECIAL DWT				
DRAWN DATE		11/11/08		
APPROV. DATE				
SCALE		1:1		
SHEET		1		
OF		1		

Franklin Fueling Systems
 11111 Franklin Road, Suite 100
 Franklin, OH 43024
 (614) 891-1111
 www.franklinfueling.com

TITLE: 2" MOUNTING ASSEMBLY
 DRAWN DATE: 11/11/08
 APPROV. DATE:
 SCALE: 1:1
 SHEET 1 OF 1

Exhibit 3

VAULTED ABOVEGROUND STORAGE TANK CONFIGURATION (Optional)

This exhibit allows an alternate tank storage configuration for the stage I EVR system. A vaulted aboveground storage tank (AST) may be installed in substitute for a conventional underground storage tank (UST). The figures in this exhibit provide examples of typical vaulted AST configurations.

General Specifications

Alternate typical vaulted AST configurations for the stage I EVR Systems are shown in Figures 5-1, 5-2, 5-3, and 5-4.

Unless otherwise specified in this attachment, the vaulted AST configuration shall comply with the applicable performance standards and performance specifications in CP-201. The emergency vent shall be a certified vent listed in this attachment for ASTs and shall be installed, operated, maintained and meet any performance requirements specified in the applicable AST CARB Executive Order.

Figure 5-1: Front Sectional Views of Typical Vaulted AST

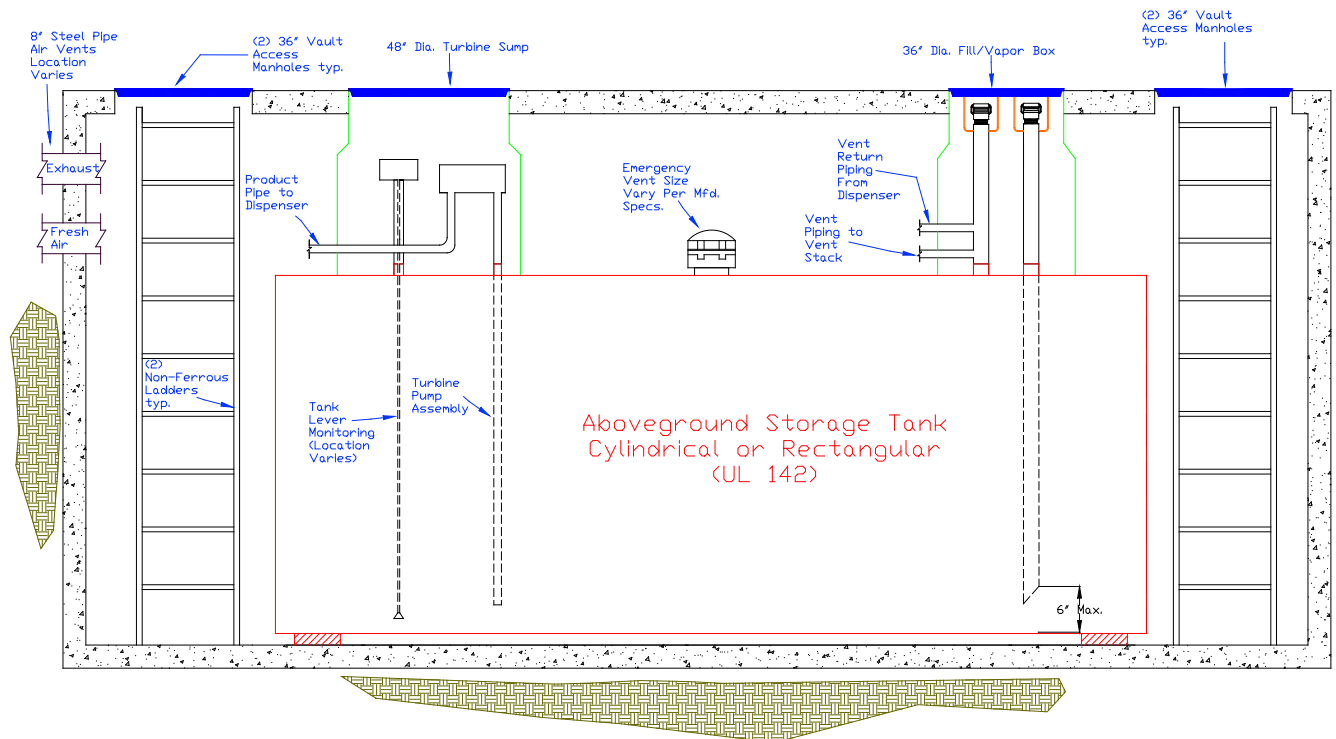

Figure 5-2: Top Sectional View of Typical Vaulted AST

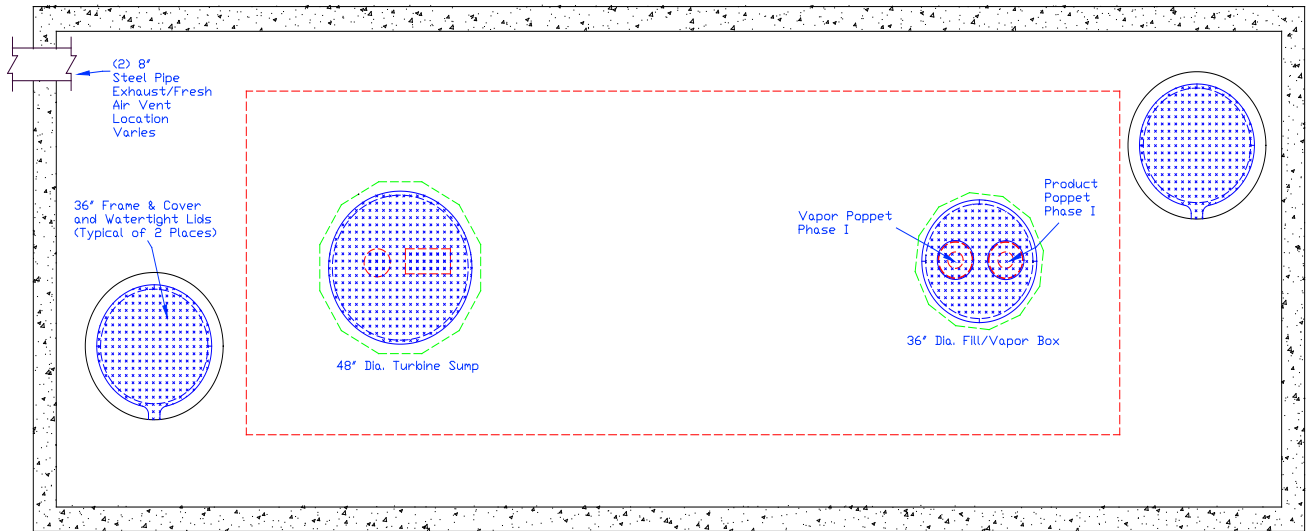

Figure 5-3: End Sectional View of Typical Vaulted AST

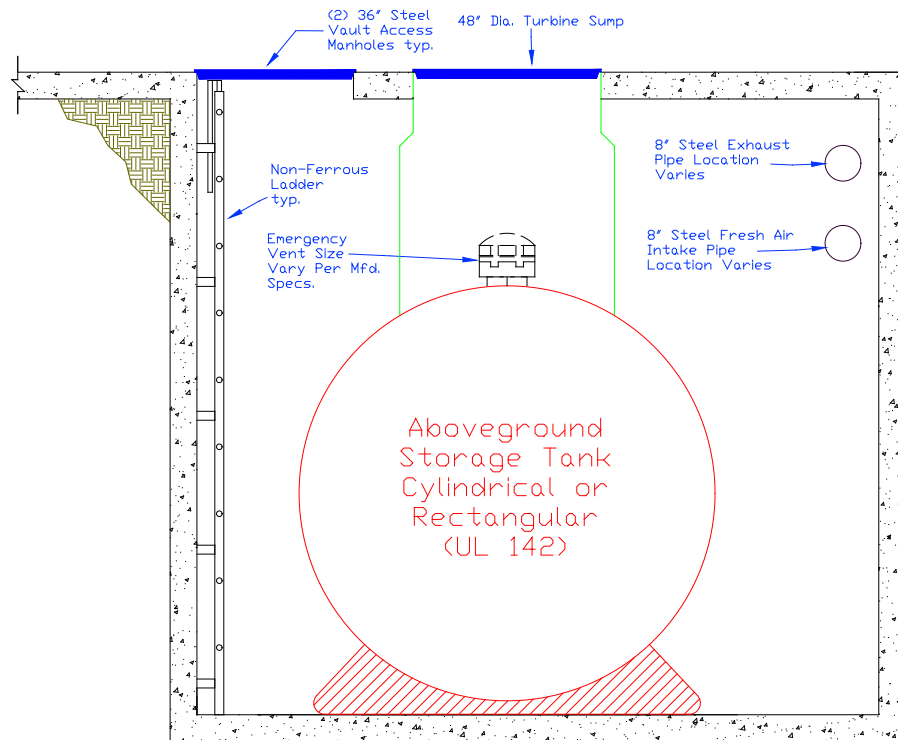

Figure 5-4: Sectional Views of Typical Vaulted AST (Ventilation)

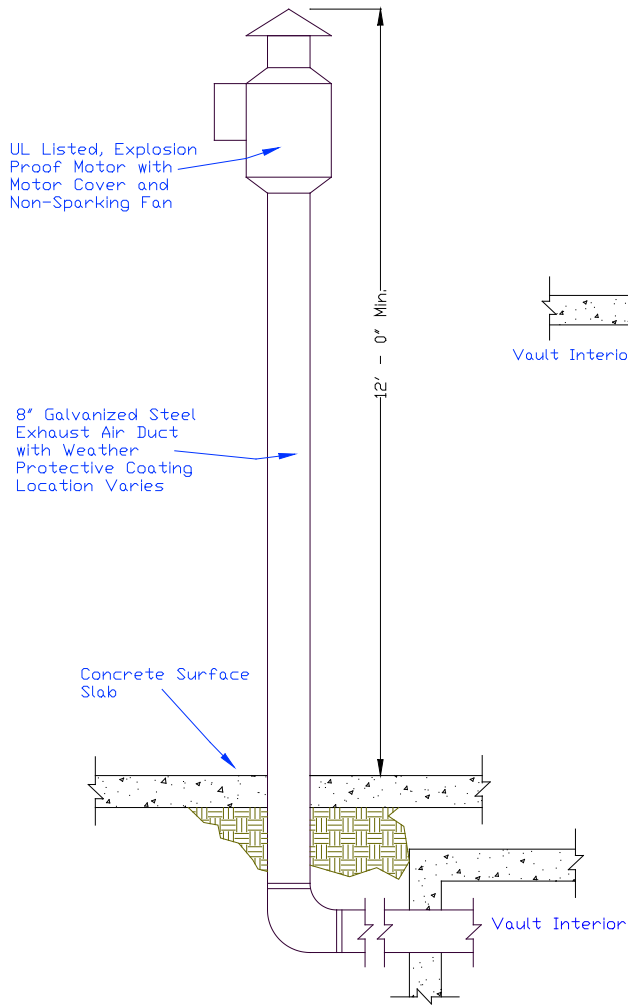

Figure 5-4a: Typical Exhaust

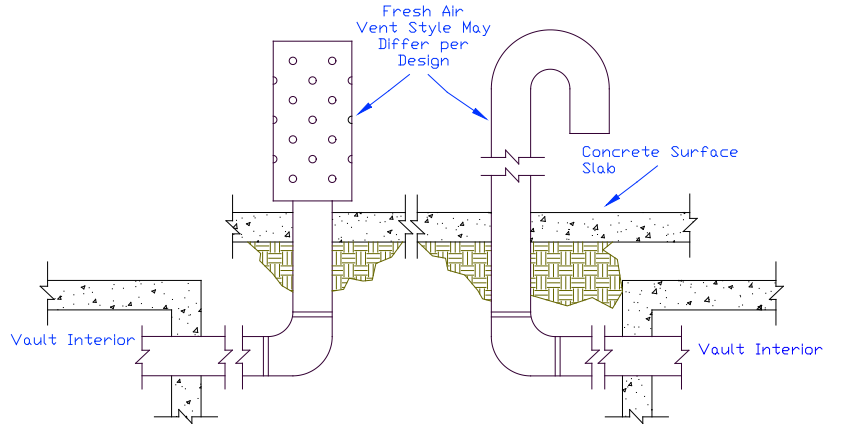

Figure 5-4b: Typical Fresh Air Intake